



GÜVEN

ELEKTRİK ELEKTRONİK LTD. ŞTİ.

GWEST®

WWOER®



OCAK 2026
FİYAT LİSTESİ

İÇİNDEKİLER

Kablo Bağları ve Aksesuarları

Standart Beyaz Kablo Bağları	04
Standart Siyah Kablo Bağları	05
Standart Renkli Kablo Bağları	06
Ultraviyole Kablo Bağları	07
Paslanmaz Çelik Kablo Bağları	08
PVC Kaplı Paslanmaz Çelik Kablo Bağları	09
Etiketli Kablo Bağları	10
Açılabilir Kablo Bağları	10
Distanslı Kablo Bağları	10
Yapışkanlı Kroşeler	11
Kapama Parçası	11
Kablo Kelepçesi	11
Kartuş Yükseltici	12
Beton Kroşe	12
Vidalı Kroşe	12
Kablo Bağı Etiket Taşıyıcı	13
Yapışkanlı Pano Etiket Taşıyıcı	13
Kablo Rakoru (PG Serisi)	14
Kablo Rakoru (Metrik Serisi)	15
Kör Tapa	16
Helezon Spiraller	17

Kablo Yüksükleri ve Uçları

İzoleli Kablo Yüksükleri Fransız Normu	20
İzoleli Kablo Yüksükleri Alman Normu	21
Çift Girişli Kablo Yüksükleri Fransız Normu	22
Çift Girişli Kablo Yüksükleri Alman Normu	23
İzolesiz Kablo Yüksükleri	24
Yuvarlak Tip İzoleli Kablo Uçları	26
Çatal Tip İzoleli Kablo Uçları	27
Ek Mufları İzoleli Kablo Uçları	28
Erkek Terminaller İzoleli Kablo Uçları	28
Dişi Terminaller İzoleli Kablo Uçları	28
Dişi Faston Tip İzoleli Kablo Uçları	29
Tam İzoleli Dişi Faston Tip Kablo Uçları	29
Tam İzoleli Polyamid Dişi Faston Tip Kablo Uçları	30
İğne Tip İzoleli Kablo Uçları	30
Erkek / Dişi Geri Dönümlü Terminaller	30
Erkek Faston Tip Terminaller	31
Tam İzoleli Polyamid Bayrak Tip Terminaller	31
İzolesiz Kablo Ucu ve Konnektörleri	32

Bağlantı Elemanları

SKP Eko Tip Kablo Pabucu	34
SKP Eko Tip Kablo Pabucu	35
SKP Standart Tip Kablo Pabucu	36
SKP Standart Tip Kablo Pabucu	37
DIN 46235 Tip Kablo Pabucu	38
DIN 46235 Tip Kablo Pabucu	39
Kaynaklı Tip Kablo Pabucu	40
Kaynaklı Tip Kablo Pabucu	41
Dar Girişli Kablo Pabucu	42
90° Kablo Pabucu	43
45° Kablo Pabucu	44
Bimetal (AL-CU) Kablo Pabucu	45
Bimetal (CAL) Kablo Pabucu	45
Ek Muf	46
DIN 46235 Tip Ek Muf	47
Delikli Montaj Rayları	48
Düz Montaj Rayları	48
Monofaze Müşterek W Otomat Baraları	49
Trifaze Müşterek W Otomat Baraları	49
2 Kutuplu Dağıtıcı Üniteler	50
4 Kutuplu Dağıtıcı Üniteler	51
Tek Kutuplu Dağıtıcı Üniteler	52
Tek Kutuplu Dağıtıcı Üniteler	53
SKP Bağlantılı Dağıtıcı Üniteler	53

Klemens Grubu

Geçmeli Buat Klemens	55
Çok Amaçlı Klemens	55
Ray Montajlı Klemens	56
(2.5mm ²) Dağıtım Bloğu	56
(2.5mm ²) Ray Montajlı Dağıtım Bloğu	57
6mm ² Besleme Girişli (2.5mm ²) Dağıtım Bloğu	57
Ray Montaj Ayağı	57

Makaron Grubu ve Bant Çeşitleri

Isı ile Daralan Siyah Makaronlar	59
Isı ile Daralan Renkli Makaronlar	60
Isı ile Daralan Kahverengi Makaronlar	61
Isı ile Daralan Sarı / Yeşil Makaronlar	62
İçi Yapışkanlı Daralan Makaronlar	63

İÇİNDEKİLER

Bara İzolasyon Makaronu	64	BA9S Led Ampuller	89
Kablo Toplama Çorabı	65	Ø 22mm Led'li Buzzer	90
Eriyen Bant	65	Motorlu Sirenler	90
H Class Cam Elyaf Silikon İzoleli Makaronlar	66	Pano İçi Termostatlar	90
		Ø 22mm Potansiyometre	91
		Ø 22mm Isımetre	91
Mekanik ve Hidrolik El Aletleri		Switch Grubu	
Yüksük Sıkma Penseleri	68	GLS Serisi Limit Switch	93
Yüksük Sıkma Penseleri	69	GLS Serisi Limit Switch	94
Kablo Ucu Sıkma Penseleri	70	GLS Serisi Limit Switch	95
Konnektör Sıkma Penseleri	71	GLS Serisi Limit Switch	96
Kablo Bağı Sıkma Penseleri	72	AZ Serisi Mikro Switch	97
Kablo Sıyırma Pensesi	72	AZ Serisi Mikro Switch	98
Kablo Pabucu Sıkma Penseleri	73	GMS Serisi Mikro Switch	99
Kablo Pabucu Sıkma Penseleri	74		
Kablo Pabucu Sıkma Penseleri	75		
Kablo Pabucu Sıkma ve Kesme Pensesi	75		
Kablo Kesme Makasları	76		
Kablo Kesme Makasları	77		
		Ayak Pedalları	
Buton Serisi ve Aksesuarları		Metal Döküm Pedal	101
Yaylı Butonlar	79	Alüminyum Döküm Pedal	101
İşaretli Yaylı Butonlar	79		
İşikly Yayly Butonlar	79		
Kalıcı Mandal Butonlar	80		
Kayıcı Mandal Butonlar	80		
Kalıcı - Kayıcı Mandal Butonlar	80		
Anahtarlı Kalıcı Butonlar	80		
İşikly Kalıcı Mandal Butonlar	81		
40mm Kalıcı Mantar Butonlar	82		
40mm Kalıcı Anahtarlı Mantar Butonlar	82		
40mm Kayıcı Mantar Butonlar	82		
İkiz Butonlar	82		
Buton Serisi Aksesuarları	83		
Boş Kumanda Kutuları	84		
Araç Vinç Kumandası	84		
Kutulu Acil Stop Buton	84		
Vinç Kumandaları	85		
Acil Stoplu Vinç Kumandaları	85		
Ø 22mm Led'li Sinyaller	86		
Ø 16mm Led'li Sinyaller	86		
Ø 22mm Led'li Sinyaller	87		
Ø 22mm Voltmetre	88		
Ø 22mm Ampermetre	88		



Bu fiyat listesindeki tipografik baskı hatalarından firmamız sorumlu değildir. Firmamız fiyat listesinde yayınlanmış olduđu teknik özellikleri deđiřtirme, döviz ve hammadde artışlarından dolayı meydana gelebilecek fiyat artışlarını hiçbir uyarıda bulunmaksızın fiyat listesine yansıtma hakkına sahiptir.

Kalite Belgelerimiz

Güven Elektrik olarak, müşteri odaklı yaklaşımımızla, sağladığımız tüm ürün ve hizmetlerde müşteri memnuniyetini en üst düzeyde tutarak kalite ve uygunluk standartları uyguluyoruz.

Yüksek seviyede ürün kalitesini ve mevzuata uygunluğu korumak temel hedefimizdir.

Kalite, firmamız açısından tartışmasız en önemli unsurdur. En kaliteli ürünleri ortaya çıkarabilmek adına; tüm hammaddelerimizi titizlikle seçmekteyiz.

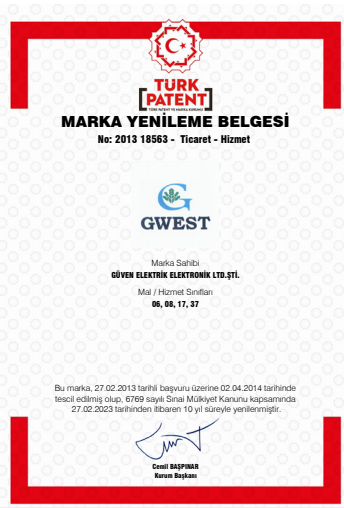

Marka/Model	Özellikler/Standartlar
0967667-TSE-0101	
28.01.2023	
28.01.2027	
GÜVEN ELEKTRİK ELEKTRONİK LTD.ŞTİ.	
GÜVEN ELEKTRİK ELEKTRONİK LTD.ŞTİ.	
İTİTİLLİ OSB MAH. MUTFAKÇILAR M2 BLOK SK. MUTFAKÇILAR SANAYİ M2 BLOK. NO:18 BAĞAŞKEHİR İSTANBUL/TÜRKİYE	
GÜVEN ELEKTRİK ELEKTRONİK LTD.ŞİRKETİ	
İTİTİLLİ OSB MAH. MUTFAKÇILAR M5 BLOK SK. MUTFAKÇILAR SANAYİ SİTESİ M5 BLOK NO:9 İSTANBUL / TÜRKİYE	
9.11.2017	
TS EN/IEC 61228-1-3:10, 12, 2019	
Kayıt Yeri Adı (C) Kağıtçılık ve Makineler Bölümü, Kağıt Fabrikası	
02.01.2026	
Belgelendirme Merkezi Başkanı Adına	
YUNUS MERCAN	
İSTANBUL, BELGELENDİRME MÜDÜRÜ V.	



Bizim Hakkımızda

2004 yılında karaköyde kurulan şirketimiz ürün çeşitliliğini arttırmayı ve bulunmuş olduğu sektörde sahip olduğu GWEST markasını en üst seviyeye taşımayı ilke olarak belirlemiştir. Müşterilerimize daha iyi hizmet sunabilmek için 2014 yılında İkitelli Organize Sanayi Bölgesi merkezine taşınmıştır. 2016 yılında ilk imalat tecrübesini yaşayan firmamız 2021 yılında 3000 m² kapalı alana sahip yeni yerine geçmiştir.

Firmamız uluslararası kalite standartların da gerçekleştirdiği hizmet ve üretimi ISO, CE ve TSE sertifikalarıyla da belgelendirmiştir.

Hedeflerimiz arasında olarak ürettiği ürünlerde yüksek kaliteye ulaşip ürün çeşitliliğini arttırıp ve koşulsuz müşteri memnuniyeti belirlemiştir. Bugüne kadar çalışmış olduğu müşterilerine koşulsuz müşteri memnuniyeti yaşatan Güven Elektrik hizmetlerine kalite standartlarını yükselterek devam etmektedir.



Tutarlı
Performans ve
Güvenilirlik
Sağlar.

GÜÇLÜ VE DAYANIKLI!

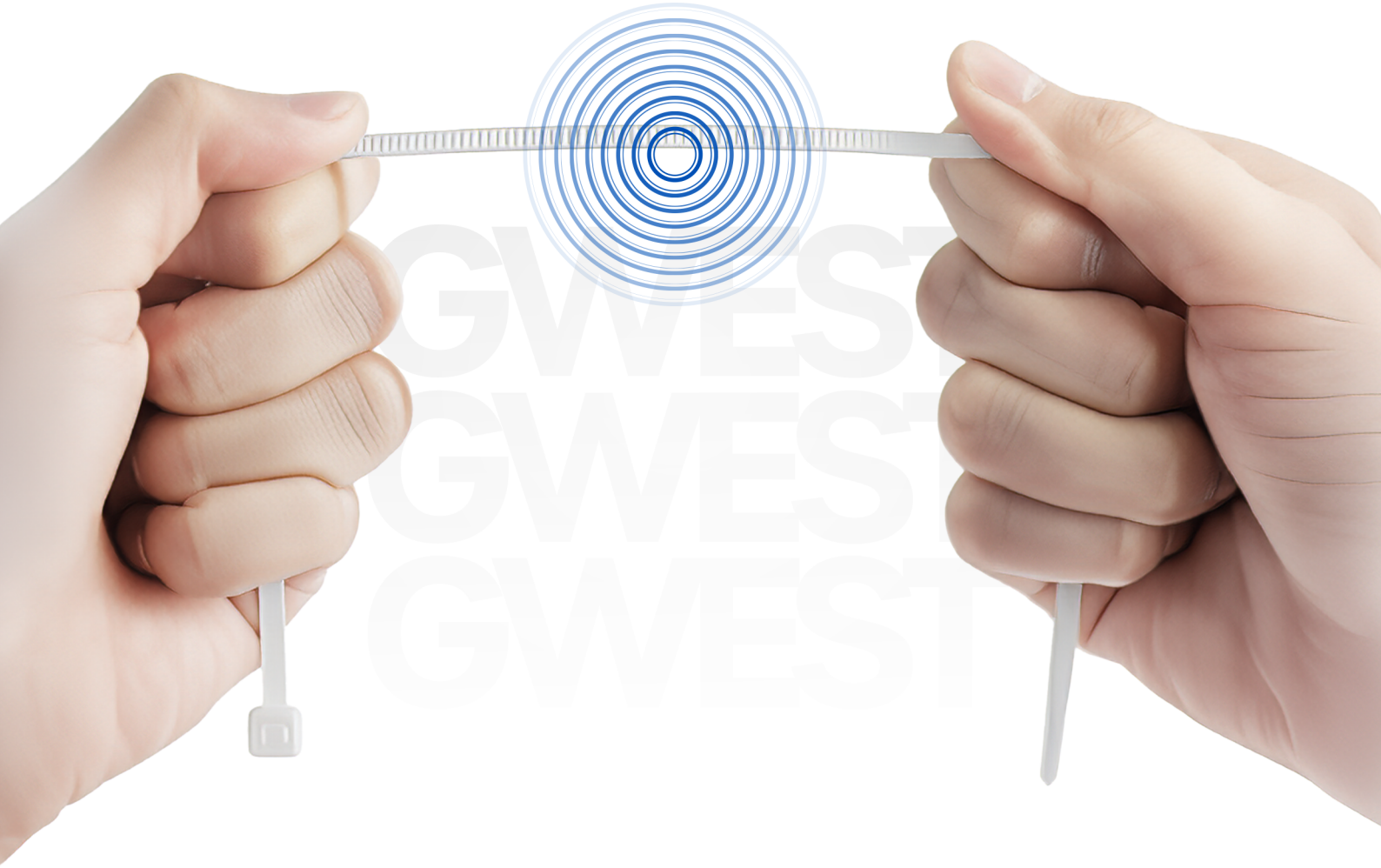

 **GÜVEN**
ELEKTRİK ELEKTRONİK LTD. ŞTİ.

GWEST®



KABLO BAĞLARI Ve Aksesuarları



www.guvenelektrik.com.tr

STANDART BEYAZ KABLO BAĞLARI

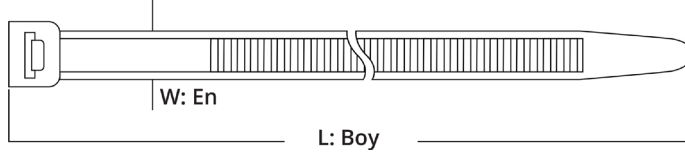
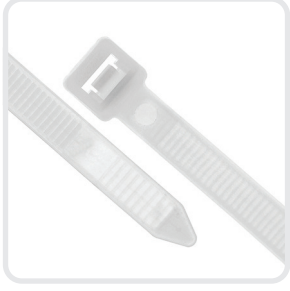

Malzeme : Saf Naylon 6.6 Standart UL
Çalışma Sıcaklığı : -40 °C --- +85 °C

Sipariş Kodu	Ürün Kodu	Boyutlar		Renk	Maksimum Sıkma Çapı (mm)	Açılma Mukavemeti (kg)	Ambalaj Adet		Birim Fiyat TL / Adet
		Uzunluk (mm)	En (mm)				Paket	Koli	
1001	GT 100 M	100	2.5	Beyaz	20	8	1.000	65.000	0,33
1002	GT 150 M	150		Beyaz	36		1.000	50.000	0,48
1003	GT 200 M	200		Beyaz	52		1.000	35.000	0,70
1004	GT 150 I	150	3.6	Beyaz	36	18	100	23.000	0,81
1005	GT 200 I	200		Beyaz	52		100	18.000	1,07
1006	GT 250 I	250		Beyaz	68		100	18.000	1,30
1007	GT 300 I	300		Beyaz	84		100	15.000	1,60
1008	GT 370 I	370		Beyaz	106		100	12.000	2,00
1009	GT 200 ST	200	4.8	Beyaz	50	22	100	13.000	1,50
1010	GT 250 ST	250		Beyaz	65		100	12.000	1,85
1011	GT 300 ST	300		Beyaz	81		100	11.000	2,30
1012	GT 370 ST	370		Beyaz	104		100	9.000	2,60
1050	GT 400 ST	400		Beyaz	113		100	6.000	3,00
1013	GT 430 ST	430		Beyaz	123		100	6.000	3,50
1015	GT 300 HD	300	7.6	Beyaz	76	55	100	5.000	4,80
1016	GT 370 HD	370		Beyaz	102		100	4.000	5,10
1017	GT 430 HD	430		Beyaz	110		100	3.000	5,50
1018	GT 530 HD	530		Beyaz	140		100	2.000	7,70
1019	GT 610 HD	610		Beyaz	185		100	2.000	9,50
1020	GT 750 HD	750		Beyaz	226		100	2.000	12,50
1022	GT 710 HD	710	9	Beyaz	190	80	100	2.000	15,00
1023	GT 780 HD	780		Beyaz	228		100	2.000	16,50
1024	GT 920 HD	920		Beyaz	280		100	1.500	19,00
1025	GT 1020 HD	1020		Beyaz	295		100	1.000	22,00
1026	GT 1220 HD	1220		Beyaz	375		100	1.000	27,00

STANDART SİYAH KABLO BAĞLARI

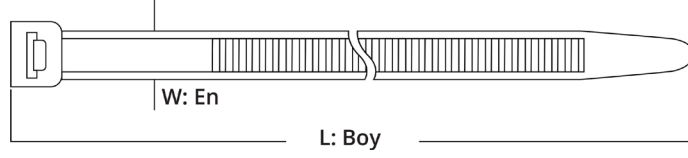

Malzeme : Saf Naylon 6.6 Standart UL
Çalışma Sıcaklığı : -40 °C --- +85 °C

Sipariş Kodu	Ürün Kodu	Boyutlar		Renk	Maksimum Sıkma Çapı (mm)	Açılma Mukavemeti (kg)	Ambalaj Adet		Birim Fiyat TL / Adet
		Uzunluk (mm)	En (mm)				Paket	Koli	
1027	GT 100 MB	100	2.5	Siyah	20	8	1.000	65.000	0,33
1028	GT 150 MB	150		Siyah	36		1.000	50.000	0,48
1029	GT 200 MB	200		Siyah	52		1.000	35.000	0,70
1030	GT 150 IB	150	3.6	Siyah	36	18	100	23.000	0,81
1031	GT 200 IB	200		Siyah	52		100	18.000	1,07
1032	GT 250 IB	250		Siyah	68		100	18.000	1,30
1033	GT 300 IB	300		Siyah	84		100	15.000	1,60
1034	GT 370 IB	370		Siyah	106		100	12.000	2,00
1035	GT 200 STB	200	4.8	Siyah	50	22	100	13.000	1,50
1036	GT 250 STB	250		Siyah	65		100	12.000	1,85
1037	GT 300 STB	300		Siyah	81		100	11.000	2,30
1038	GT 370 STB	370		Siyah	104		100	9.000	2,60
1039	GT 430 STB	430		Siyah	123		100	6.000	3,50
1041	GT 300 HDB	300	7.6	Siyah	76	55	100	5.000	4,80
1042	GT 370 HDB	370		Siyah	102		100	4.000	5,10
1043	GT 430 HDB	430		Siyah	110		100	3.000	5,50
1044	GT 530 HDB	530		Siyah	140		100	2.000	7,70
1045	GT 610 HDB	610		Siyah	185		100	2.000	9,50
1046	GT 750 HDB	750		Siyah	226		100	2.000	12,50
1048	GT 710 HDB	710	9	Siyah	190	80	100	2.000	15,00
1049	GT 780 HDB	780		Siyah	228		100	2.000	16,50
1051	GT 920 HDB	920		Siyah	280		100	1.500	19,00

STANDART RENKLİ KABLO BAĞLARI

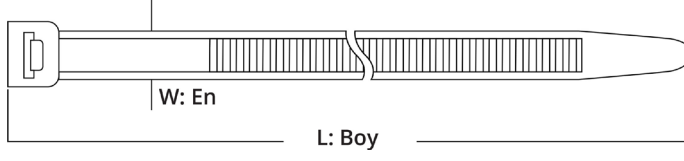
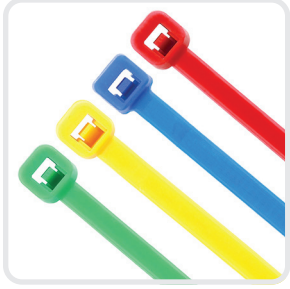

Malzeme : Saf Naylon 6.6 Standart UL
Çalışma Sıcaklığı : -40 °C --- +85 °C

Sipariş Kodu	Ürün Kodu	Boyutlar		Renk	Maksimum Sıkma Çapı (mm)	Açılma Mukavemeti (kg)	Ambalaj Adet		Birim Fiyat TL / Adet
		Uzunluk (mm)	En (mm)				Paket	Koli	
1101	GT 100 MK	100	2.5	Kırmızı	20	8	1.000	65.000	0,37
1102	GT 150 IK	150	3.6	Kırmızı	36	18	100	23.000	0,90
1103	GT 200 IK	200		Kırmızı	52		100	18.000	1,20
1104	GT 250 IK	250		Kırmızı	68		100	18.000	1,45
1105	GT 300 IK	300		Kırmızı	84		100	15.000	1,80
1106	GT 200 STK	200		4.8	Kırmızı		50	22	100
1107	GT 250 STK	250	Kırmızı		65	100	12.000		2,00
1108	GT 300 STK	300	Kırmızı		81	100	11.000		2,55
1109	GT 370 STK	370	Kırmızı		101	100	9.000		2,90
1110	GT 100 MM	100	2.5	Mavi	20	8	1.000	65.000	0,37
1111	GT 150 IM	150	3.6	Mavi	36	18	100	23.000	0,90
1112	GT 200 IM	200		Mavi	52		100	18.000	1,20
1113	GT 250 IM	250		Mavi	68		100	18.000	1,45
1114	GT 300 IM	300		Mavi	84		100	15.000	1,80
1115	GT 200 STM	200		4.8	Mavi		50	22	100
1116	GT 250 STM	250	Mavi		65	100	12.000		2,00
1117	GT 300 STM	300	Mavi		81	100	11.000		2,55
1118	GT 370 STM	370	Mavi		101	100	9.000		2,90
1119	GT 100 MS	100	2.5	Sarı	20	8	1.000	65.000	0,37
1120	GT 150 IS	150	3.6	Sarı	36	18	100	23.000	0,90
1121	GT 200 IS	200		Sarı	52		100	18.000	1,20
1122	GT 250 IS	250		Sarı	68		100	18.000	1,45
1123	GT 300 IS	300		Sarı	84		100	15.000	1,80
1124	GT 200 STS	200		4.8	Sarı		50	22	100
1125	GT 250 STS	250	Sarı		65	100	12.000		2,00
1126	GT 300 STS	300	Sarı		81	100	11.000		2,55
1127	GT 370 STS	370	Sarı		104	100	9.000		2,90
1128	GT 100 MY	100	2.5	Yeşil	20	8	1.000	65.000	0,37
1129	GT 150 IY	150	3.6	Yeşil	36	18	100	23.000	0,90
1130	GT 200 IY	200		Yeşil	52		100	18.000	1,20
1131	GT 250 IY	250		Yeşil	68		100	18.000	1,45
1132	GT 300 IY	300		Yeşil	84		100	15.000	1,80
1133	GT 200 STY	200		4.8	Yeşil		50	22	100
1134	GT 250 STY	250	Yeşil		65	100	12.000		2,00
1135	GT 300 STY	300	Yeşil		81	100	11.000		2,55
1136	GT 370 STY	370	Yeşil		101	100	9.000		2,90

ULTRAVİOLE KABLO BAĞLARI

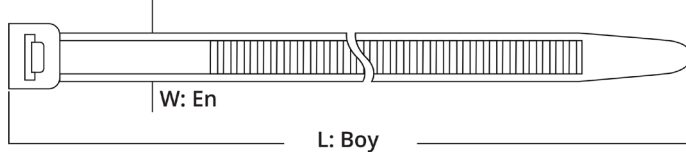

Malzeme : Saf Naylon 6.6 Standart UL
Çalışma Sıcaklığı : -40 °C --- +85 °C

Sipariş Kodu	Ürün Kodu	Boyutlar		Renk	Maksimum Sıkma Çapı (mm)	Açılma Mukavemeti (kg)	Ambalaj Adet		Birim Fiyat TL / Adet
		Uzunluk (mm)	En (mm)				Paket	Koli	
1201	GT 100 M UV	100	2.5	Siyah	20	8	1.000	65.000	0,37
1202	GT 150 M UV	150		Siyah	36		1.000	50.000	0,54
1203	GT 200 M UV	200		Siyah	52		1.000	35.000	0,77
1204	GT 150 I UV	150	3.6	Siyah	36	18	100	23.000	0,90
1205	GT 200 I UV	200		Siyah	52		100	18.000	1,20
1206	GT 250 I UV	250		Siyah	68		100	18.000	1,45
1207	GT 300 I UV	300		Siyah	84		100	15.000	1,80
1208	GT 200 ST UV	200	4.8	Siyah	50	22	100	13.000	1,70
1209	GT 250 ST UV	250		Siyah	65		100	12.000	2,00
1210	GT 300 ST UV	300		Siyah	81		100	11.000	2,55
1211	GT 370 ST UV	370		Siyah	104		100	9.000	2,90
1212	GT 430 ST UV	430		Siyah	123		100	6.000	4,00
1213	GT 300 HD UV	300	7.6	Siyah	76	55	100	5.000	5,40
1214	GT 370 HD UV	370		Siyah	102		100	4.000	5,80
1215	GT 430 HD UV	430		Siyah	110		100	3.000	6,30
1216	GT 530 HD UV	530		Siyah	140		100	2.000	8,60
1217	GT 780 HD UV	780	9	Siyah	228	80	100	2.000	18,50



PASLANMAZ ÇELİK KABLO BAĞLARI

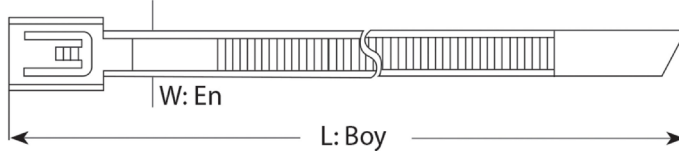

Malzeme : 304 Paslanmaz Çelik
Su Emilimi: Yok
Alev Yürümeme : UL94V-2

Sipariş Kodu	Ürün Kodu	Boyutlar		Renk	Maksimum Sıkma Çapı (mm)	Açılma Mukavemeti (kg)	Ambalaj Adet		Birim Fiyat TL / Adet
		Uzunluk (mm)	En (mm)				Paket	Koli	
1301	MTL 150 ST	150	4.6	Metal	44	55	100	8.000	5,00
1302	MTL 200 ST	200		Metal	51		100	6.000	5,60
1303	MTL 260 ST	260		Metal	69		100	5.000	6,50
1304	MTL 300 ST	300		Metal	76		100	5.000	6,80
1305	MTL 370 ST	370		Metal	102		100	4.000	7,50
1306	MTL 520 ST	520		Metal	152		100	3.000	9,50
1307	MTL 680 ST	680		Metal	203		100	2.000	11,50
1308	MTL 840 ST	840		Metal	254		100	1.000	14,00
1309	MTL 200 HD	200	7.9	Metal	50	120	100	5.000	9,00
1310	MTL 300 HD	300		Metal	75		100	4.000	10,50
1311	MTL 370 HD	370		Metal	102		100	3.000	12,50
1312	MTL 520 HD	520		Metal	152		100	2.000	15,00
1313	MTL 680 HD	680		Metal	203		100	2.000	18,00
1314	MTL 840 HD	840		Metal	224		100	1.000	22,00

Paslanmaz Çelik Kablo Bağları

- Kendiliğinden kilitlenebilir kafa tasarımı, kurulumu hızlandırır ve kablo bağı gövdesi boyunca herhangi bir boyda kilitlemeyi sağlar.
- Güçlü ve dayanıklı kablo bağlama yöntemini temin eder.
- Çok çeşitli iç mekân ve dış mekân uygulama alanlarında kullanılabilir.
- Pürüzsüz yüzeyi ve yuvarlatılmış uçları ile kabloların korunmasını ve çalışan kişinin güvenliğini garanti eder.
- Şebeke kablolarında en üst düzey desteği sağlar.
- Genel amaçlı uygulamalar için : 304 paslanmaz çelik



PVC KAPLI PASLANMAZ ÇELİK KABLO BAĞLARI

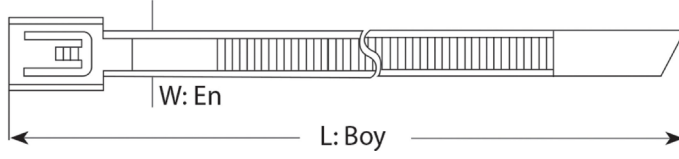

Malzeme : 304 Paslanmaz Çelik
Su Emilimi: Yok
Alev Yürümeme : UL94V-2

Sipariş Kodu	Ürün Kodu	Boyutlar		Renk	Maksimum Sıkma Çapı (mm)	Açılma Mukavemeti (kg)	Ambalaj Adet		Birim Fiyat TL / Adet
		Uzunluk (mm)	En (mm)				Paket	Koli	
1401	PVC MTL 150 ST	150	4.6	Metal	44	55	100	8.000	7,00
1402	PVC MTL 200 ST	200		Metal	51		100	6.000	7,80
1403	PVC MTL 260 ST	260		Metal	69		100	5.000	8,70
1404	PVC MTL 300 ST	300		Metal	76		100	5.000	9,60
1405	PVC MTL 370 ST	370		Metal	102		100	4.000	11,50
1406	PVC MTL 520 ST	520		Metal	152		100	3.000	15,00
1407	PVC MTL 680 ST	680		Metal	203		100	2.000	18,50
1408	PVC MTL 840 ST	840		Metal	254		100	1.000	23,50
1409	PVC MTL 200 HD	200	7.9	Metal	50	120	100	5.000	12,00
1410	PVC MTL 300 HD	300		Metal	75		100	4.000	14,50
1411	PVC MTL 370 HD	370		Metal	102		100	3.000	17,00
1412	PVC MTL 520 HD	520		Metal	152		100	2.000	21,00
1413	PVC MTL 680 HD	680		Metal	203		100	2.000	27,00
1414	PVC MTL 840 HD	840		Metal	224		100	1.000	32,00

PVC Kaplı Paslanmaz Çelik Kablo Bağları

- Kendiliğinden kilitlenebilen kafa tasarımı, kurulumu hızlandırır ve kablo bağı gövdesi boyunca herhangi bir boyda kilitlemeyi sağlar.
- Güçlü ve dayanıklı kablo bağlama yöntemini temin eder.
- Çok çeşitli iç mekân ve dış mekân uygulama alanlarında kullanılabilir.
- Pürüzsüz yüzeyi ve yuvarlatılmış uçları ile kablunun korunmasını ve çalışan kişinin güvenliğini garanti eder.
- Şebeke kablolarında en üst düzey desteği sağlar.
- Genel amaçlı uygulamalar için : 304 paslanmaz çelik



ETİKETLİ KABLO BAĞLARI

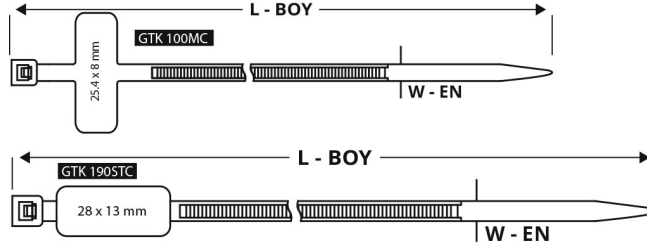

Malzeme : Saf Naylon 6.6 Standart UL
Çalışma Sıcaklığı : -40 °C --- +85 °C

Sipariş Kodu	Ürün Kodu	Boyutlar		Renk	Maksimum Sıkma Çapı (mm)	Açılma Mukavemeti (kg)	Ambalaj Adet		Birim Fiyat TL / Adet
		Uzunluk (mm)	En (mm)				Paket	Koli	
1501	GTK 100 MC	100	2.5	Beyaz	20	8	100	30.000	1,20
1502	GTK 190 STC	190	4.8	Beyaz	48	22	100	15.000	2,80

AÇILABİLİR KABLO BAĞLARI

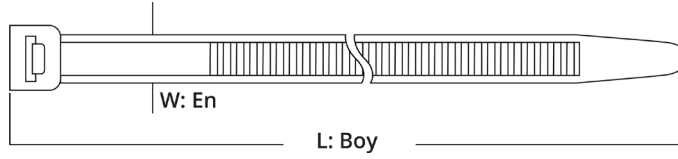

Malzeme : Saf Naylon 6.6 Standart UL
Çalışma Sıcaklığı : -40 °C --- +85 °C

Sipariş Kodu	Ürün Kodu	Boyutlar		Renk	Maksimum Sıkma Çapı (mm)	Açılma Mukavemeti (kg)	Ambalaj Adet		Birim Fiyat TL / Adet
		Uzunluk (mm)	En (mm)				Paket	Koli	
1503	GTA 200 HD	200	7.6	Beyaz	50	36	100	2.000	3,90
1504	GTA 370 HD	370	7.6	Beyaz	100	36	100	2.000	6,00

DİSTANSLI KABLO BAĞLARI

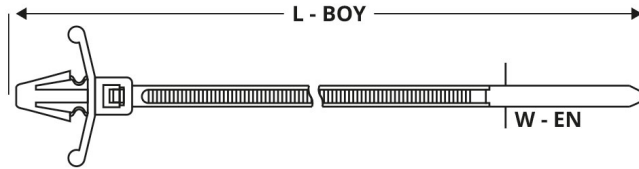

Malzeme : Saf Naylon 6.6 Standart UL
Çalışma Sıcaklığı : -40 °C --- +85 °C

Sipariş Kodu	Ürün Kodu	Boyutlar		Renk	Maksimum Sıkma Çapı (mm)	Açılma Mukavemeti (kg)	Ambalaj Adet		Birim Fiyat TL / Adet
		Uzunluk (mm)	En (mm)				Paket	Koli	
1505	GTP 100 M	100	2.5	Beyaz	20	8	100	15.000	1,10
1506	GTP 150 I	150	3.6	Beyaz	35	18	100	10.000	1,60
1507	GTP 200 ST	200	4.8	Beyaz	50	22	100	5.000	3,30

YAPIŞKANLI KROŞE

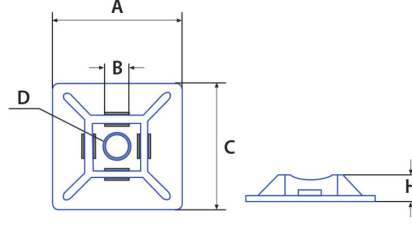
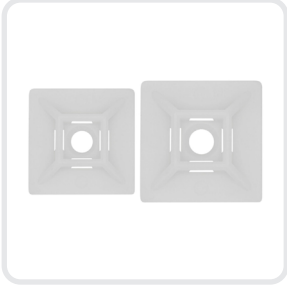

Malzeme : Saf Naylon 6.6 Standart UL
Çalışma Sıcaklığı : -40 °C --- +85 °C

Sipariş Kodu	Ürün Kodu	Boyutlar					Renk	Ambalaj Adet		Birim Fiyat TL / Adet
		A	B	C	D	H		Paket	Koli	
1513	HW - 3A	19	19	3.6	Ø 3.2	4.0	Beyaz	100	20.000	1,80
1514	HW - 4A	28	28	4.8	Ø 3.2	4.5	Beyaz	100	9.000	3,25
1515	HW - 3AB	19	19	3.6	Ø 3.2	4.0	Siyah	100	20.000	1,80
1516	HW - 4AB	28	28	4.8	Ø 3.2	4.5	Siyah	100	9.000	3,25

KAPAMA PARÇASI

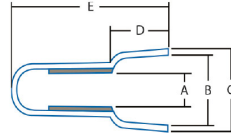
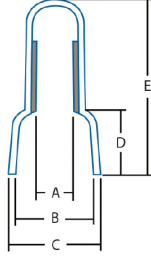

Malzeme : Saf Naylon 6.6 Standart UL
Çalışma Sıcaklığı : -40 °C --- +85 °C

Sipariş Kodu	Ürün Kodu	Boyutlar					Renk	Ambalaj Adet		Birim Fiyat TL / Adet
		A	B	C	D	H		Paket	Koli	
1517	HW - C4	19	19	3.6	Ø 3.2	4.0	Beyaz	100	20.000	1,00
1518	HW - C5	28	28	4.8	Ø 3.2	4.5	Beyaz	100	10.000	1,80

KABLO KELEPÇESİ

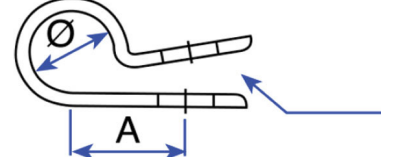
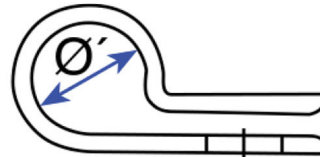
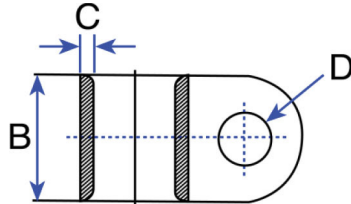

Sipariş Kodu	Ürün Kodu	Boyutlar						Renk	Ambalaj Adet		Birim Fiyat TL / Adet
		Ø	Ø1	A	B	C	D		Paket	Koli	
1523	GCL 1/4	7.4	6.6	10.3	9.1	1.27	M5	Beyaz	100	20.000	1,20
1524	GCL 3/8	10.9	9.7	11.9	9.2	1.27	M5	Beyaz	100	10.000	1,55

KARTUŞ YÜKSELTİCİ

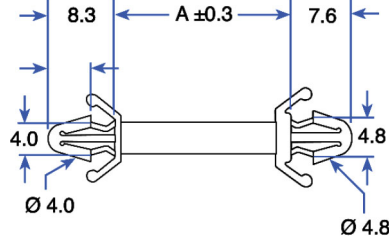
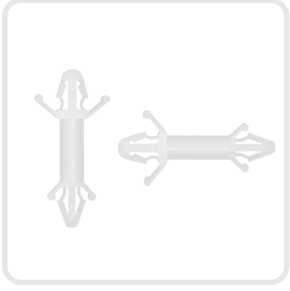

Malzeme : Saf Naylon 6.6 Standart UL
Çalışma Sıcaklığı : -40 °C --- +85 °C

Sipariş Kodu	Ürün Kodu	Boyutlar		Renk	Ambalaj Adet		Birim Fiyat TL / Adet
		A			Paket	Koli	
1519	CBS - 9A	9.2		Beyaz	1.000	25.000	1,55
1520	CBS - 13A	12.6		Beyaz	1.000	25.000	1,70

BETON KROŞE

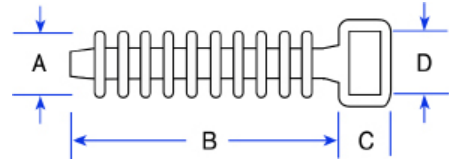

Sipariş Kodu	Ürün Kodu	Boyutlar				Maksimum Sıkma Çapı (mm)	Renk	Ambalaj Adet		Birim Fiyat TL / Adet
		A	B	C	D			Paket	Koli	
1525	TH - 2	9.5	36.0	6.0	9.5	9.5	Siyah	100	8.000	2,25

VİDALI KROŞE

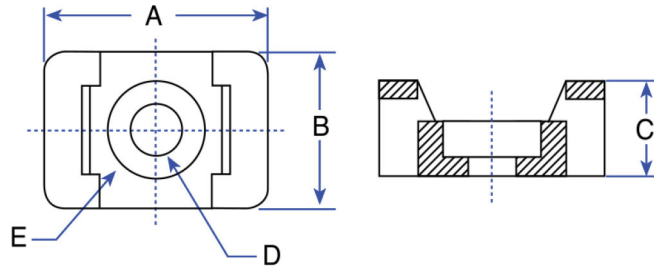

Sipariş Kodu	Ürün Kodu	Boyutlar					Maksimum Sıkma Çapı (mm)	Renk	Ambalaj Adet		Birim Fiyat TL / Adet
		A	B	C	D	E			Paket	Koli	
1511	VK V - 1	14.9	9.5	6.9	4.5	7.8	4.8	Beyaz	100	20.000	1,35
1512	VK V - 2	22.2	15.9	9.7	6.4	12.6	7.6	Beyaz	100	10.000	1,95

KABLO BAĞI ETİKET TAŞIYICI

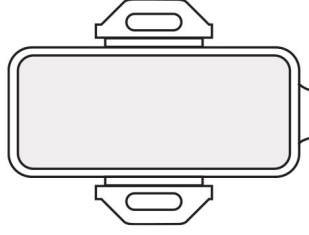

Malzeme : Polipropilen

Çalışma Sıcaklığı : 0 °C --- +90 °C

Sipariş Kodu	Ürün Kodu	Boyutlar			Etiket Eni (mm)	Etiket Boyu (mm)	Renk	Ambalaj Adet		Birim Fiyat TL / Adet
		A	B	C				Paket	Koli	
1526	GET - 1	35	10	8	32	7	Beyaz	100	8.000	3,20
1527	GET - 2	45	20	8	42	17	Beyaz	100	4.000	5,80

YAPIŞKANLI PANO ETİKET TAŞIYICI

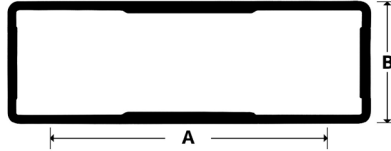
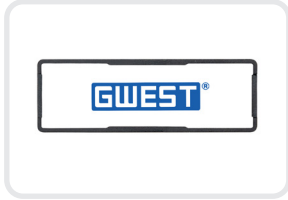

Malzeme : ABS Altılık, PS Kapak +

Çift Taraflı Bant

Çalışma Sıcaklığı : -40 °C --- +60 °C

Sipariş Kodu	Ürün Kodu	Boyutlar		Etiket Eni (mm)	Etiket Boyu (mm)	Renk	Ambalaj Adet		Birim Fiyat TL / Adet
		A	B				Paket	Koli	
1528	GPET - 1	30	17	27.5	14.4	Siyah	100	8.000	3,90
1529	GPET - 2	50	17	49	15	Siyah	50	5.000	5,50
1530	GPET - 3	75	17	72	15	Siyah	25	3.000	7,20

KABLO RAKORU (PG SERİSİ)

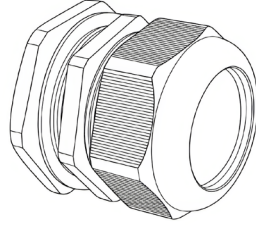

Malzeme : Polyamid 6
Çalışma Sıcaklığı : -20 °C --- +100 °C
Dayanıklılık: IP68

Sipariş Kodu	Ürün Kodu	Metrik	Sıkma Çapı	Renk	Ambalaj Adet		Birim Fiyat TL / Adet
					Paket	Koli	
1600	GW-7G	PG-7	3-6,5 mm	Gri	450	4.500	8,00
1601	GW-9G	PG-9	4-6 mm	Gri	300	3.000	9,50
1602	GW-11G	PG-11	5-10 mm	Gri	200	2.000	11,50
1603	GW-13,5G	PG-13,5	6-12 mm	Gri	175	1.750	12,50
1604	GW-16G	PG-16	10-14 mm	Gri	125	1.250	16,50
1605	GW-21G	PG-21	13-18 mm	Gri	75	750	28,00
1606	GW-29G	PG-29	18-25 mm	Gri	40	400	47,00
1607	GW-36G	PG-36	22-32 mm	Gri	20	200	82,00
1608	GW-42G	PG-42	32-38 mm	Gri	15	150	102,00
1609	GW-48G	PG-48	37-44 mm	Gri	12	120	117,00
1610	GW-7S	PG-7	3-6,5 mm	Siyah	450	4.500	8,00
1611	GW-9S	PG-9	4-6 mm	Siyah	300	3.000	9,50
1612	GW-11S	PG-11	5-10 mm	Siyah	200	2.000	11,50
1613	GW-13,5S	PG-13,5	6-12 mm	Siyah	175	1.750	12,50
1614	GW-16S	PG-16	10-14 mm	Siyah	125	1.250	16,50
1615	GW-21S	PG-21	13-18 mm	Siyah	75	750	28,00
1616	GW-29S	PG-29	18-25 mm	Siyah	40	400	47,00
1617	GW-36S	PG-36	22-32 mm	Siyah	20	200	82,00
1618	GW-42S	PG-42	32-38 mm	Siyah	15	150	102,00
1619	GW-48S	PG-48	37-44 mm	Siyah	12	120	117,00

KABLO RAKORU (METRİK SERİSİ)

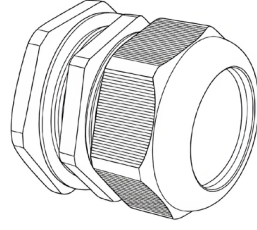
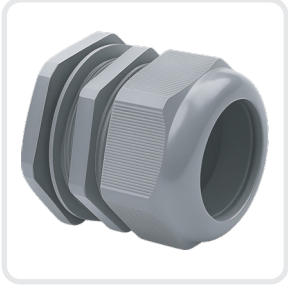

Malzeme : Polyamid 6

Çalışma Sıcaklığı : -20 °C --- +100 °C

Dayanıklılık : IP68

Sipariş Kodu	Ürün Kodu	Metrik	Sıkma Çapı	Renk	Ambalaj Adet		Birim Fiyat TL / Adet
					Paket	Koli	
1620	GW-12MG	M12x1,5	3-6,5 mm	Gri	450	4.500	8,50
1621	GW-16MG	M16x1,5	5-10 mm	Gri	200	2.000	11,80
1622	GW-20MG	M20x1,5	6-12 mm	Gri	175	1.750	13,00
1623	GW-20MKG	M20x1,5	10-14 mm	Gri	125	1.250	17,00
1624	GW-25MG	M25x1,5	13-18 mm	Gri	75	750	28,50
1625	GW-32MG	M32x1,5	18-25 mm	Gri	40	400	48,00
1626	GW-40MG	M40x1,5	22-32 mm	Gri	20	200	83,00
1627	GW-50MG	M50x1,5	32-38 mm	Gri	15	150	104,00
1628	GW-63MG	M63x1,5	37-44 mm	Gri	12	120	121,00
1629	GW-12MS	M12x1,5	3-6,5 mm	Siyah	450	4.500	8,50
1630	GW-16MS	M16x1,5	5-10 mm	Siyah	200	2.000	11,80
1631	GW-20MS	M20x1,5	6-12 mm	Siyah	175	1.750	13,00
1632	GW-20MKS	M20x1,5	10-14 mm	Siyah	125	1.250	17,00
1633	GW-25MS	M25x1,5	13-18 mm	Siyah	75	750	28,50
1634	GW-32MS	M32x1,5	18-25 mm	Siyah	40	400	48,00
1635	GW-40MS	M40x1,5	22-32 mm	Siyah	20	200	83,00
1636	GW-50MS	M50x1,5	32-38 mm	Siyah	15	150	104,00
1637	GW-63MS	M63x1,5	37-44 mm	Siyah	12	120	121,00

KÖR TAPA

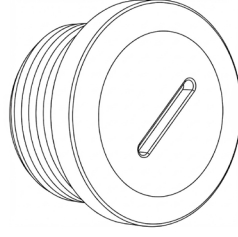

Malzeme : Polyamid 6
Çalışma Sıcaklığı : -20 °C --- +100 °C
Dayanıklılık: IP68

Sipariş Kodu	Ürün Kodu	Metrik	Renk	Ambalaj Adet		Birim Fiyat TL / Adet
				Paket	Koli	
1638	GW-7KG	PG-7	Gri	1.200	12.000	5,20
1639	GW-9KG	PG-9	Gri	1.000	10.000	6,30
1640	GW-11KG	PG-11	Gri	800	8.000	7,80
1641	GW-13,5KG	PG-13,5	Gri	500	5.000	9,00
1642	GW-16KG	PG-16	Gri	350	3.500	11,00
1643	GW-21KG	PG-21	Gri	200	2.000	17,50
1644	GW-29KG	PG-29	Gri	150	1.500	25,00
1645	GW-36KG	PG-36	Gri	50	500	37,00
1646	GW-42KG	PG-42	Gri	35	350	50,00
1647	GW-48KG	PG-48	Gri	20	200	60,00
1648	GW-7KS	PG-7	Siyah	1.200	12.000	5,20
1649	GW-9KS	PG-9	Siyah	1.000	10.000	6,30
1650	GW-11KS	PG-11	Siyah	800	8.000	7,80
1651	GW-13,5KS	PG-13,5	Siyah	500	5.000	9,00
1652	GW-16KS	PG-16	Siyah	350	3.500	11,00
1653	GW-21KS	PG-21	Siyah	200	2.000	17,50
1654	GW-29KS	PG-29	Siyah	150	1.500	25,00
1655	GW-36KS	PG-36	Siyah	50	500	37,00
1656	GW-42KS	PG-42	Siyah	35	350	50,00
1657	GW-48KS	PG-48	Siyah	20	200	60,00

HELEZON SPİRALLER

Sipariş Kodu	Ürün Kodu	O.D.	T	W	Kablo Kesit (mm ²)	Renk	Paket Miktarı (Mt.)	Koli Miktarı (Mt.)	Birim Fiyat TL / Mt
3251	GHS6 (No1)	6	0.60	7.4	2.5 - 15	Beyaz	10	1.000	9,00
3252	GHS8 (No2)	8	0.75	12	6 - 30	Beyaz	10	800	11,00
3253	GHS10 (No3)	10	0.80	12.3	7.5 - 30	Beyaz	10	500	13,50
3254	GHS12 (No4)	12	0.85	15	9 - 32	Beyaz	10	400	17,00
3255	GHS15 (No5)	15	1.00	15.5	12 - 35	Beyaz	10	250	29,00

Malzeme : PE

Esnek yapısı sayesinde kabloların düzenlemesine yardımcı olur.
Güçlü yapısı sayesinde tekrar kullanım için uygundur.

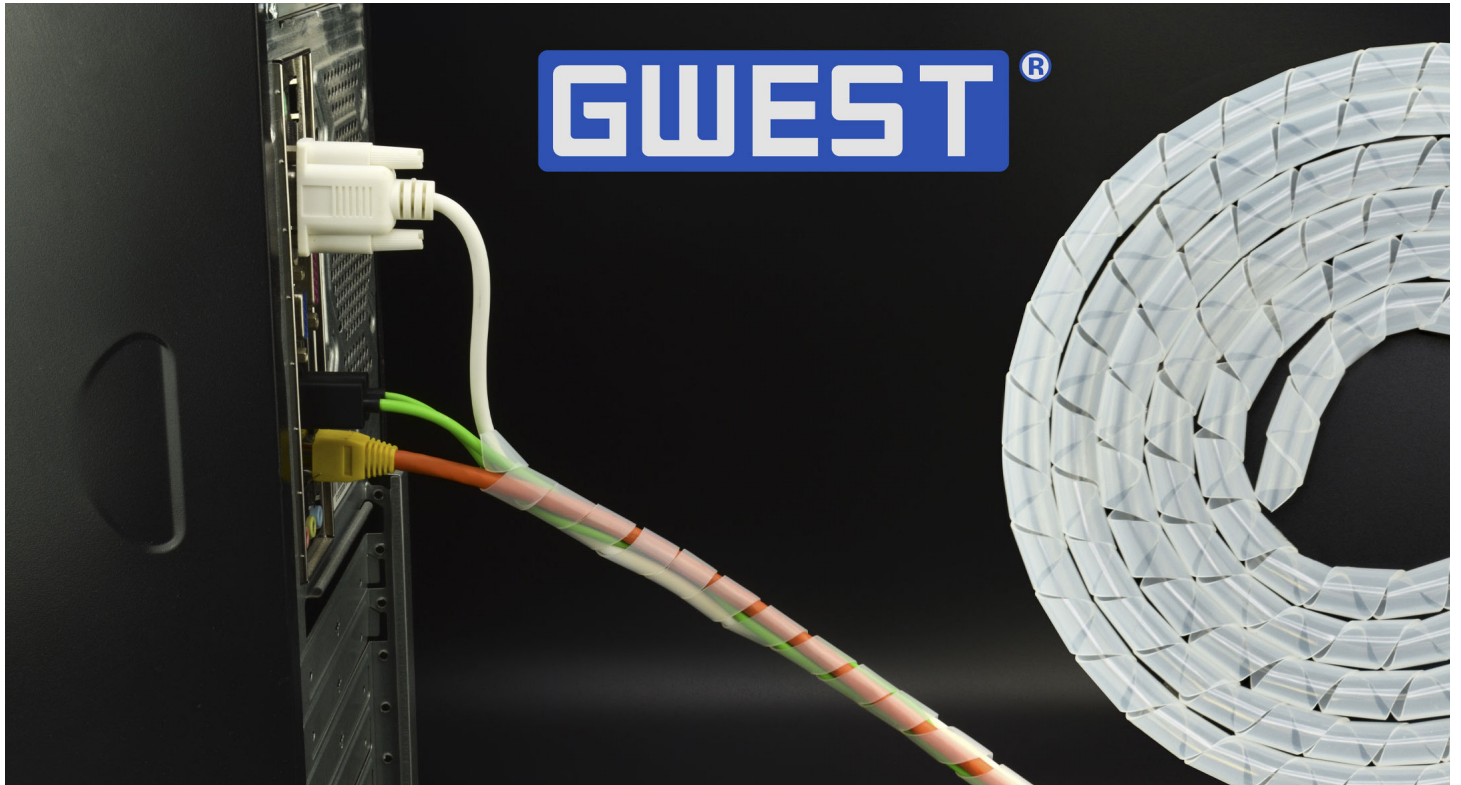
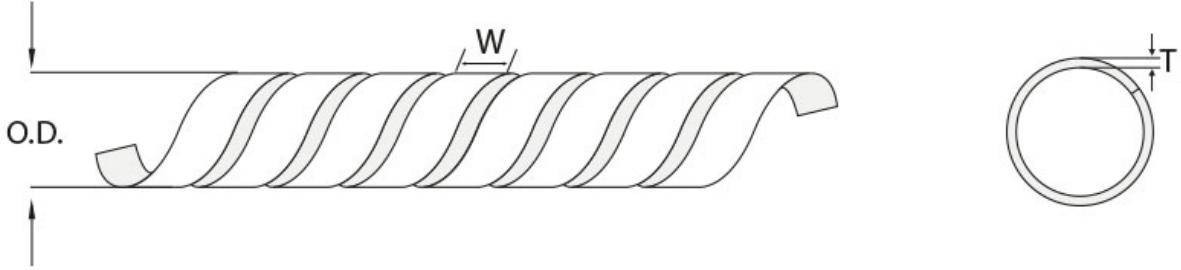

Güvenli Sıkma,
Kesintisiz
iletim

GÜCÜ NOKTADA **SABİTLER!**



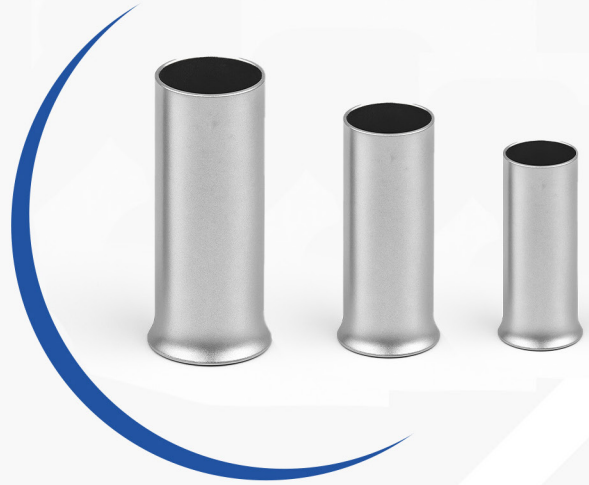

KABLO YÜKSÜKLERİ

Tek ve Çift Girişli



www.guvenelektrik.com.tr

İZOLELİ KABLO YÜKSÜKLERİ FRANSIZ NORMU



Standart : DIN 46228
 Malzeme : Bakır, Kalay Kaplı
 İzolasyon : Naylon
 Çalışma Sıcaklığı : Maksimum 105° 600Volt Arası

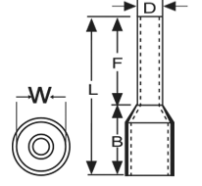

Sipariş Kodu	Ürün Kodu	Renk	Kablo Kesit (mm ²)	Ebatlar (mm)					Kutu Adet	Birim Fiyat TL / Adet
				F	L	W	B	D		
2001	IYF - 0.25	Menekşe	0.25 mm ²	8.0	12.0	1.9	4.4	1.1	1.000	1,20
2002	IYF - 0.34	Pembe	0.34 mm ²	8.0	12.0	1.9	4.4	1.1	1.000	1,20
2003	IYF - 0.50	Beyaz	0.50 mm ²	8.0	14.0	2.6	6.0	1.3	1.000	0,55
2004	IYF - 0.75	Mavi	0.75 mm ²	8.0	14.0	2.8	6.3	1.5	1.000	0,55
2005	IYF - 1.0	Kırmızı	1.00 mm ²	8.0	14.0	3.0	6.3	1.7	1.000	0,55
2006	IYF - 1.5	Siyah	1.50 mm ²	8.0	14.0	3.5	6.3	2.0	1.000	0,61
2007	IYF - 2.5	Gri	2.50 mm ²	8.0	14.0	4.2	7.4	2.5	500	0,78
2008	IYF - 4.0	Turuncu	4.00 mm ²	10.0	17.0	4.8	7.4	3.2	500	1,30
2009	IYF - 6.0	Yeşil	6.00 mm ²	12.0	20.0	6.3	8.5	3.9	250	1,80
2010	IYF - 10.0	Kahve	10.0 mm ²	12.0	22.0	7.6	8.8	4.9	100	2,25
2011	IYF - 16.0	Bej	16.0 mm ²	12.0	24.0	8.8	10.0	6.2	100	3,10
2012	IYF - 25.0	Siyah	25.0 mm ²	16.0	28.0	11.2	12.0	7.7	50	5,20
2013	IYF - 35.0	Kırmızı	35.0 mm ²	16.0	30.0	12.7	14.0	8.7	50	6,50
2014	IYF - 50.0	Mavi	50.0 mm ²	20.0	36.0	15.0	16.0	10.9	25	12,00
2015	IYF - 70.0	Sarı	70.0 mm ²	21.0	37.0	16.0	17.0	14.3	25	22,00



İZOLELİ KABLO YÜKSÜKLERİ ALMAN NORMU



Standart : DIN 46228
 Malzeme : Bakır, Kalay Kaplı
 İzolasyon : Naylon
 Çalışma Sıcaklığı : Maksimum 105° 600Volt Arası

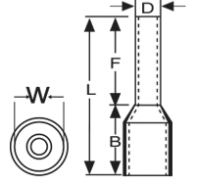

Sipariş Kodu	Ürün Kodu	Renk	Kablo Kesit (mm ²)	Ebatlar (mm)					Kutu Adet	Birim Fiyat TL / Adet
				F	L	W	B	D		
2101	IYA - 0.14	Gri	0.14 mm ²	8.0	12.0	1.6	2.8	0.9	1.000	1,20
2102	IYA - 0.25	Mavi	0.25 mm ²	8.0	12.0	1.9	4.4	1.1	1.000	1,20
2103	IYA - 0.34	Turkuaz	0.34 mm ²	8.0	12.0	1.9	4.4	1.1	1.000	1,20
2104	IYA - 0.50	Turuncu	0.50 mm ²	8.0	14.0	2.6	6.0	1.3	1.000	0,55
2105	IYA - 0.75	Beyaz	0.75 mm ²	8.0	14.0	2.8	6.3	1.5	1.000	0,55
2106	IYA - 1.0	Sarı	1.00 mm ²	8.0	14.0	3.0	6.3	1.7	1.000	0,55
2107	IYA - 1.5	Kırmızı	1.50 mm ²	8.0	14.0	3.5	6.3	2.0	1.000	0,61
2108	IYA - 2.5	Mavi	2.50 mm ²	8.0	14.0	4.2	7.4	2.5	500	0,78
2109	IYA - 4.0	Gri	4.00 mm ²	10.0	17.0	4.8	7.4	3.2	500	1,30
2110	IYA - 6.0	Siyah	6.00 mm ²	12.0	20.0	6.3	8.5	3.9	250	1,80
2111	IYA - 10.0	Bej	10.0 mm ²	12.0	22.0	7.6	8.8	4.9	100	2,25
2112	IYA - 16.0	Yeşil	16.0 mm ²	12.0	24.0	8.8	10.0	6.2	100	3,10
2113	IYA - 25.0	Kahve	25.0 mm ²	16.0	28.0	11.2	12.0	7.7	50	5,20
2114	IYA - 35.0	Bej	35.0 mm ²	16.0	30.0	12.7	14.0	8.7	50	6,50
2115	IYA - 50.0	Yeşil	50.0 mm ²	20.0	36.0	15.0	16.0	10.9	25	12,00



ÇİFT GİRİŞLİ KABLO YÜKSÜKLERİ FRANSIZ NORMU



Standart : DIN 46228
 Malzeme : Bakır, Kalay Kaplı
 İzolasyon : Naylon
 Çalışma Sıcaklığı : Maksimum 105° 600Volt Arası

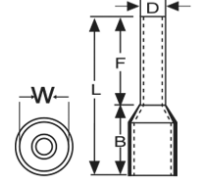

Sipariş Kodu	Ürün Kodu	Renk	Kablo Kesit (mm ²)	Ebatlar (mm)					Kutu Adet	Birim Fiyat TL / Adet
				F	L	W	B	D		
2201	CYF - 0.50	Beyaz	0.50 mm ²	8.0	14.0	5.0	6.5	1.8	1.000	0,98
2202	CYF - 0.75	Mavi	0.75 mm ²	8.0	14.0	5.5	6.7	2.1	500	1,05
2203	CYF - 1.0	Kırmızı	1.00 mm ²	8.0	14.0	5.5	7.1	2.4	500	1,10
2204	CYF - 1.5	Siyah	1.50 mm ²	8.0	14.0	6.4	7.5	2.6	500	1,35
2205	CYF - 2.5	Gri	2.50 mm ²	10.0	14.0	8.0	8.5	3.3	250	2,15
2206	CYF - 4.0	Turuncu	4.00 mm ²	12.0	17.0	8.0	11.1	4.2	200	2,50
2207	CYF - 6.0	Yeşil	6.00 mm ²	14.0	20.0	9.5	12.1	5.3	100	3,10
2208	CYF - 10.0	Kahve	10.0 mm ²	14.0	27.0	12.6	12.6	6.9	50	4,75
2209	CYF - 16.0	Bej	16.0 mm ²	14.0	31.0	19.0	17.3	8.7	50	6,00



ÇİFT GİRİŞLİ KABLO YÜKSÜKLERİ ALMAN NORMU



Standart : DIN 46228
 Malzeme : Bakır, Kalay Kaplı
 İzolasyon : Naylon
 Çalışma Sıcaklığı : Maksimum 105° 600Volt Arası

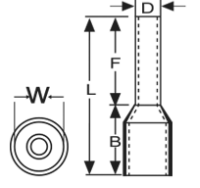

Sipariş Kodu	Ürün Kodu	Renk	Kablo Kesit (mm ²)	Ebatlar (mm)					Kutu Adet	Birim Fiyat TL / Adet
				F	L	W	B	D		
2301	CYA - 0.50	Turuncu	0.50 mm ²	8.0	14.0	5.0	6.5	1.8	1000	0,98
2302	CYA - 0.75	Beyaz	0.75 mm ²	8.0	14.0	5.5	6.7	2.1	500	1,05
2303	CYA - 1.0	Sarı	1.00 mm ²	8.0	14.0	5.5	7.1	2.4	500	1,10
2304	CYA - 1.5	Kırmızı	1.50 mm ²	8.0	14.0	6.4	7.5	2.6	500	1,35
2305	CYA - 2.5	Mavi	2.50 mm ²	10.0	14.0	8.0	8.5	3.3	250	2,15
2306	CYA - 4.0	Gri	4.00 mm ²	12.0	17.0	8.0	11.1	4.2	200	2,50
2307	CYA - 6.0	Siyah	6.00 mm ²	14.0	20.0	9.5	12.1	5.3	100	3,10
2308	CYA - 10.0	Bej	10.0 mm ²	14.0	27.0	12.6	12.6	6.9	50	4,75
2309	CYA - 16.0	Yeşil	16.0 mm ²	14.0	31.0	19.0	17.3	8.7	50	6,00

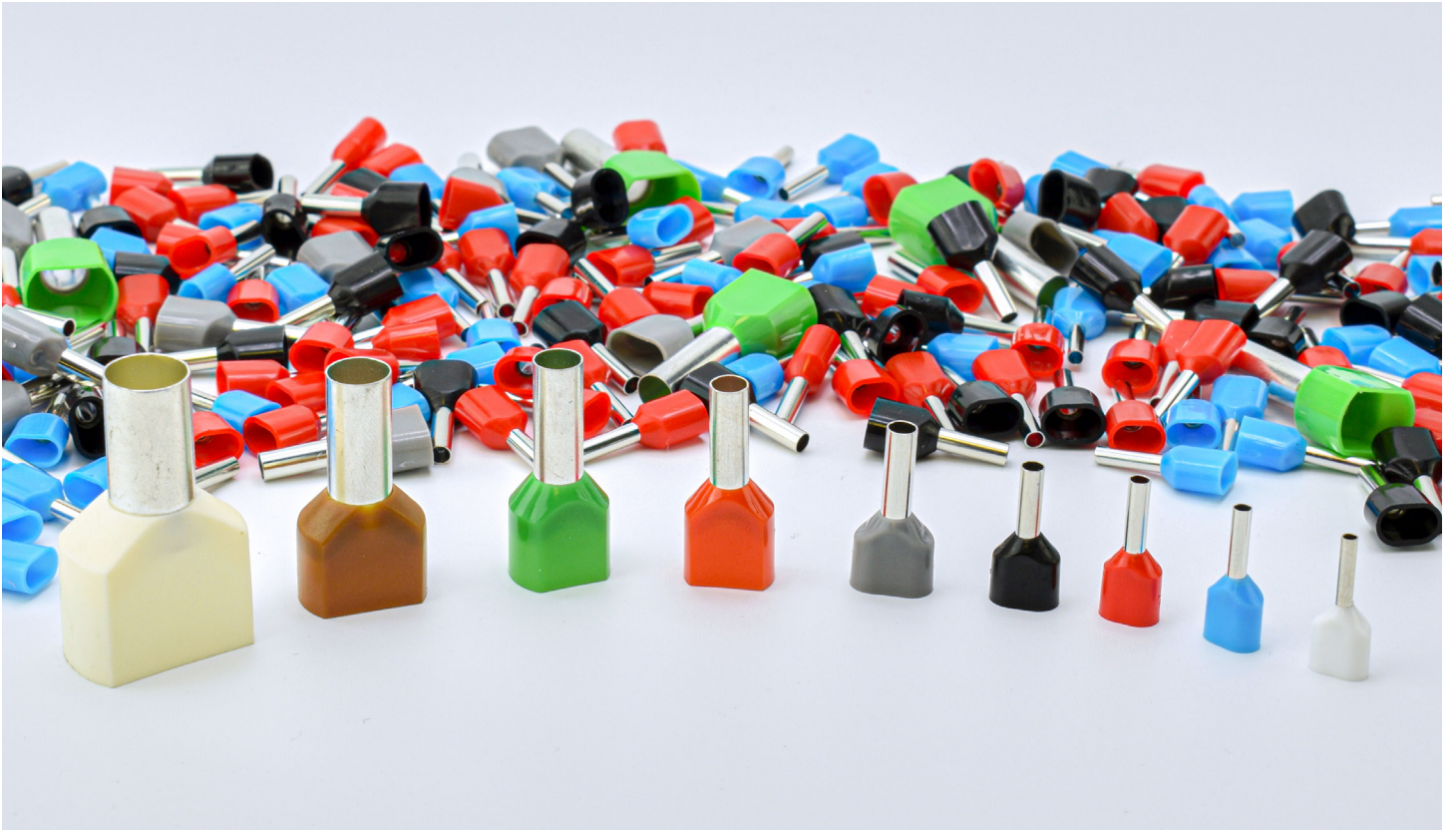

İZOLESİZ KABLO YÜKSÜKLERİ



Standart : DIN 46228
 Malzeme : Bakır, Kalay Kaplı
 İzolasyon : Yok

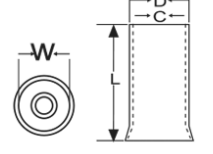

Sipariş Kodu	Ürün Kodu	Kablo Kesit (mm ²)	Ebatlar (mm)				Kutu Adet	Birim Fiyat TL / Adet
			L	W	D	C		
2401	KY - 0.50	0.50 mm ²	10	2.1	1.3	1.0	2.000	0,55
2402	KY - 0.75	0.75 mm ²	10	2.3	1.5	1.2	1.000	0,55
2403	KY - 1.0	1.00 mm ²	10	2.5	1.7	1.4	1.000	0,55
2404	KY - 1.5	1.50 mm ²	10	2.8	2.0	1.7	1.000	0,61
2405	KY - 2.5	2.50 mm ²	12	3.4	2.5	2.2	1.000	0,85
2406	KY - 4.0	4.00 mm ²	12	4.0	3.2	2.8	1.000	1,15
2407	KY - 6.0	6.00 mm ²	12	4.7	3.9	3.5	500	1,55
2408	KY - 10.0	10.0 mm ²	15	5.8	4.9	4.5	250	2,60
2409	KY - 16.0	16.0 mm ²	15	7.5	6.2	5.8	250	3,20





KABLO UÇLARI Ve Terminaller



YUVARLAK TİP İZOLELİ KABLO UÇLARI

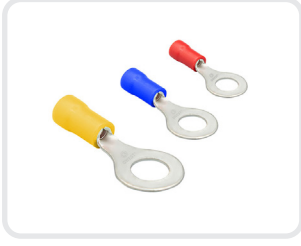

Standart : DIN 46237
 Malzeme : Bakır, Kalay Kaplı
 İzolasyon : PVC
 Çalışma Sıcaklığı : Maksimum 105° 600Volt Arası

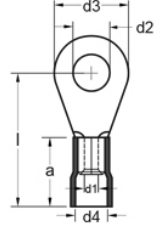

Sipariş Kodu	Ürün Kodu	Renk	Kablo Kesit (mm ²)	Civata Ölçüsü	Ebatlar (mm)						Kutu Adet	Birim Fiyat TL / Adet
					d2	d3	l	d1	d4	a		
3001	GYU - 301	■ Kırmızı	0.50 - 1.50 mm ²	M3	3.2	6.0	16.0	1.6	4.0	10.0	200	1,80
3003	GYU - 401	■ Kırmızı		M4	4.3	8.0	17.0	1.6	4.0	10.0	200	2,60
3004	GYU - 501	■ Kırmızı		M5	5.3	10.0	18.0	1.6	4.0	10.0	200	2,65
3005	GYU - 601	■ Kırmızı		M6	6.5	10.0	18.0	1.6	4.0	10.0	200	4,20
3006	GYU - 801	■ Kırmızı		M8	8.4	14.0	22.0	1.6	4.0	10.0	200	4,20
3007	GYU - 302	■ Mavi	1.50 - 2.50 mm ²	M3	3.2	6.0	16.0	2.3	4.5	10.0	200	3,20
3008	GYU - 402	■ Mavi		M4	4.3	8.0	17.0	2.3	4.5	10.0	200	3,20
3009	GYU - 502	■ Mavi		M5	5.3	10.0	19.0	2.3	4.5	10.0	200	3,30
3010	GYU - 602	■ Mavi		M6	6.5	11.0	20.0	2.3	4.5	10.0	200	4,70
3011	GYU - 802	■ Mavi		M8	8.4	14.0	22.0	2.3	4.5	10.0	200	4,70
3012	GYU - 1002	■ Mavi	M10	10.5	15.0	22.0	2.3	4.5	10.0	200	4,80	
3013	GYU - 406	■ Sarı	4.00 - 6.00 mm ²	M4	4.3	8.6	21.0	3.6	6.3	13.0	100	6,80
3014	GYU - 506	■ Sarı		M5	5.3	10.0	22.0	3.6	6.3	13.0	100	6,80
3015	GYU - 606	■ Sarı		M6	6.5	11.0	22.5	3.6	6.3	13.0	100	7,70
3016	GYU - 806	■ Sarı		M8	8.4	14.0	26.0	3.6	6.3	13.0	100	10,00
3017	GYU - 1006	■ Sarı		M10	10.5	18.0	28.0	3.6	6.3	13.0	100	10,00
3018	GYU - 1206	■ Sarı	M12	13.0	18.0	28.0	3.6	6.3	13.0	100	10,20	
3019	GYU - 610	■ Kırmızı	8.00 - 10.00 mm ²	M6	6.7	23.5	30.0	4.5	8.0	17.0	50	11,20
3020	GYU - 810	■ Kırmızı		M8	8.4	26.3	36.0	4.5	8.0	17.0	50	13,50

ÇATAL TİP İZOLELİ KABLO UÇLARI

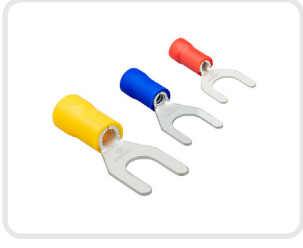

Standart : DIN 46237
 Malzeme : Bakır, Kalay Kaplı
 İzolasyon : PVC
 Çalışma Sıcaklığı : Maksimum 105° 600Volt Arası

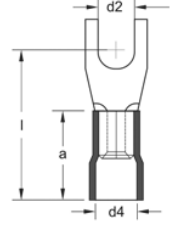

Sipariş Kodu	Ürün Kodu	Renk	Kablo Kesit (mm ²)	Civata Ölçüsü	Ebatlar (mm)						Kutu Adet	Birim Fiyat TL / Adet
					d2	d3	l	d1	d4	a		
3101	GÇU - 3001	Kırmızı	0.50 - 1.50 mm ²	M3	3.2	6.0	16.0	1.6	4.0	10.0	200	2,40
3102	GÇU - 4001	Kırmızı		M4	4.3	8.0	17.0	1.6	4.0	10.0	200	2,45
3103	GÇU - 5001	Kırmızı		M5	5.3	10.0	18.0	1.6	4.0	10.0	200	2,55
3104	GÇU - 6001	Kırmızı		M6	6.5	11.0	20.0	1.6	4.0	10.0	200	2,90
3105	GÇU - 3002	Mavi	1.50 - 2.50 mm ²	M3	3.2	5.5	18.0	2.3	4.5	10.0	200	2,65
3106	GÇU - 4002	Mavi		M4	4.3	6.8	17.0	2.3	4.5	10.0	200	2,75
3107	GÇU - 5002	Mavi		M5	5.3	10.0	19.0	2.3	4.5	10.0	200	2,85
3108	GÇU - 6002	Mavi		M6	6.5	11.0	21.0	2.3	4.5	10.0	200	3,70
3109	GÇU - 4006	Sarı	4.00 - 6.00 mm ²	M4	4.3	8.0	21.0	3.6	6.3	13.0	100	6,00
3110	GÇU - 5006	Sarı		M5	5.3	10.0	22.0	3.6	6.3	13.0	100	6,00
3111	GÇU - 6006	Sarı		M6	6.5	11.0	23.0	3.6	6.3	13.0	100	8,00
3112	GÇU - 8006	Sarı		M8	8.4	14.0	26.0	3.6	6.3	13.0	100	9,50

EK MUFLARI İZOLELİ KABLO UÇLARI



Standart : DIN 46237
 Malzeme : Bakır, Kalay Kaplı
 İzolasyon : PVC
 Çalışma Sıcaklığı : Maksimum 75° 600Volt Arası

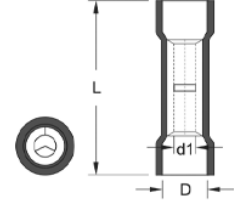

Sipariş Kodu	Ürün Kodu	Renk	Kablo Kesit (mm ²)	Ebatlar (mm)			Kutu Adet	Birim Fiyat TL / Adet
				L	D	d1		
3201	GBY - 251	Kırmızı	0.50 - 1.50 mm ²	24.6	4.0	1.7	200	3,70
3202	GBY - 252	Mavi	1.50 - 2.50 mm ²	24.6	4.5	2.3	200	3,70
3203	GBY - 256	Sarı	4.00 - 6.00 mm ²	26.5	6.3	3.4	100	6,25

ERKEK TERMİNALLER İZOLELİ KABLO UÇLARI



Malzeme : Pirinç, Kalay Kaplı, Bakır Yüksüklü
 İzolasyon : PVC
 Çalışma Sıcaklığı : Maksimum 75° 600Volt Arası

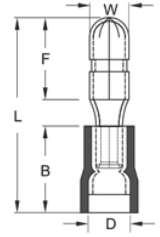

Sipariş Kodu	Ürün Kodu	Renk	Kablo Kesit (mm ²)	Ebatlar (mm)					Kutu Adet	Birim Fiyat TL / Adet
				W	F	L	B	D		
3204	GBE - 1040	Kırmızı	0.50 - 1.50 mm ²	4.0	8.5	21.5	10.5	3.8	200	6,20
3205	GBE - 2050	Mavi	1.50 - 2.50 mm ²	5.0	8.5	21.2	10.5	4.7	200	7,10
3206	GBE - 5050	Sarı	4.00 - 6.00 mm ²	5.0	8.5	24.0	13.0	6.2	200	9,40

DİŞİ TERMİNALLER İZOLELİ KABLO UÇLARI



Malzeme : Pirinç, Kalay Kaplı, Bakır Yüksüklü
 İzolasyon : PVC
 Çalışma Sıcaklığı : Maksimum 75° 600Volt Arası

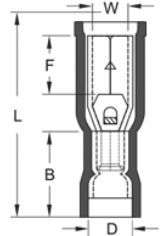

Sipariş Kodu	Ürün Kodu	Renk	Kablo Kesit (mm ²)	Ebatlar (mm)					Kutu Adet	Birim Fiyat TL / Adet
				W	F	L	B	D		
3207	GBD - 1040	Kırmızı	0.50 - 1.50 mm ²	3.9	7.0	23.3	10.5	3.8	200	7,40
3208	GBD - 2050	Mavi	1.50 - 2.50 mm ²	4.9	7.0	23.3	10.5	4.7	100	8,40
3209	GBD - 5050	Sarı	4.00 - 6.00 mm ²	4.9	7.0	25.1	12.5	6.2	100	10,40

DİŞİ FASTON TİP İZOLELİ KABLO UÇLARI



Malzeme : Pirinç, Kalay Kaplı
İzolasyon : PVC
Çalışma Sıcaklığı : Maksimum 75° 600Volt Arası

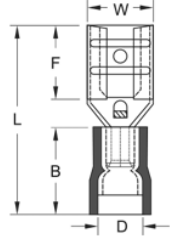

Sipariş Kodu	Ürün Kodu	Renk	Kablo Kesit (mm ²)	Soket Genişliği	Ebatlar (mm)					Kutu Adet	Birim Fiyat TL / Adet
					W	F	L	B	D		
3210	GFD - 1288	Kırmızı	0.50 - 1.50 mm ²	0.8 x 2.80	3.2	6.5	19.0	10.5	3.8	200	1,60
3211	GFD - 1488	Kırmızı		0.8 x 4.75	5.0	6.4	19.4	10.5	3.8	200	2,10
3212	GFD - 1638	Kırmızı		0.8 x 6.35	6.6	7.5	20.8	10.5	3.8	200	2,75
3213	GFD - 2288	Mavi	1.50 - 2.50 mm ²	0.8 x 2.80	3.2	6.5	19.0	10.5	4.7	200	2,10
3214	GFD - 2488	Mavi		0.8 x 4.75	5.0	6.4	19.4	10.5	4.7	200	2,20
3215	GFD - 2638	Mavi		0.8 x 6.35	6.6	7.5	20.8	10.5	4.7	200	2,75
3216	GFD - 5638	Sarı	4.00 - 6.00 mm ²	0.8 x 6.35	6.6	7.5	23.3	13.0	6.2	200	3,10

TAM İZOLELİ DİŞİ FASTON TİP KABLO UÇLARI



Malzeme : Pirinç, Kalay Kaplı
İzolasyon : PVC
Çalışma Sıcaklığı : Maksimum 75° 600Volt Arası

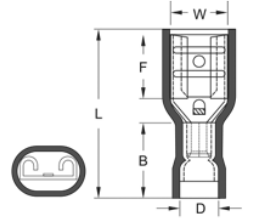

Sipariş Kodu	Ürün Kodu	Renk	Kablo Kesit (mm ²)	Soket Genişliği	Ebatlar (mm)					Kutu Adet	Birim Fiyat TL / Adet
					W	F	L	B	D		
3218	GFFD - 1288	Kırmızı	0.50 - 1.50 mm ²	0.8 x 2.80	3.2	6.5	19.0	10.5	3.8	200	2,65
3219	GFFD - 1488	Kırmızı		0.8 x 4.75	5.0	6.4	20.5	10.5	3.8	200	3,10
3220	GFFD - 1638	Kırmızı		0.8 x 6.35	6.6	7.5	21.8	10.5	3.8	200	3,70
3221	GFFD - 2288	Mavi	1.50 - 2.50 mm ²	0.8 x 2.80	3.2	6.5	20.0	10.5	4.7	200	3,10
3222	GFFD - 2488	Mavi		0.8 x 4.75	5.0	6.4	20.2	10.5	4.7	200	3,20
3223	GFFD - 2638	Mavi		0.8 x 6.35	6.6	7.5	22.2	10.5	4.7	200	3,80
3224	GFFD - 5638	Sarı	4.00 - 6.00 mm ²	0.8 x 6.35	6.6	7.5	24.2	12.5	6.2	100	4,50

TAM İZOLELİ POLYAMİD DİŞİ FASTON TİP KABLO UÇLARI



Malzeme : Pirinç, Kalay Kaplı
İzolasyon : Polyamid
Çalışma Sıcaklığı : Maksimum 105° 600Volt Arası

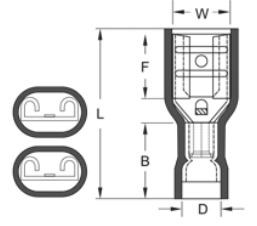

Sipariş Kodu	Ürün Kodu	Renk	Kablo Kesit (mm ²)	Soket Genişliği	Ebatlar (mm)					Kutu Adet	Birim Fiyat TL / Adet
					W	F	L	B	D		
3225	GPFD - 1638	■ Kırmızı	0.50 - 1.50 mm ²	0.8 x 6.35	6.6	7.5	21.5	11.0	4.0	200	9,30
3226	GPFD - 2638	■ Mavi	1.50 - 2.50 mm ²	0.8 x 6.35	6.6	7.5	21.5	11.0	5.0	200	9,30
3227	GPFD - 5638	■ Sarı	4.00 - 6.00 mm ²	0.8 x 6.35	6.6	7.5	24.2	13.0	6.5	100	11,20

İĞNE TİP İZOLELİ KABLO UÇLARI

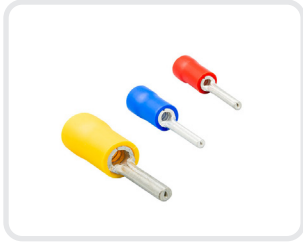

Malzeme : Pirinç, Kalay Kaplı
İzolasyon : PVC
Çalışma Sıcaklığı : Maksimum 75° 600Volt Arası

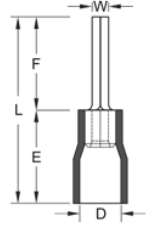

Sipariş Kodu	Ürün Kodu	Renk	Kablo Kesit (mm ²)	Ebatlar (mm)					Kutu Adet	Birim Fiyat TL / Adet
				W	F	L	E	D		
3228	GİK - 101	■ Kırmızı	0.50 - 1.50 mm ²	1.9	10.0	19.0	10.0	4.0	200	2,80
3229	GİK - 102	■ Mavi	1.50 - 2.50 mm ²	1.9	12.0	21.8	10.0	4.5	200	3,40
3230	GİK - 106	■ Sarı	4.00 - 6.00 mm ²	2.8	14.0	27.0	27.0	6.4	100	8,00

ERKEK / DİŞİ GERİ DÖNÜŞLÜ TERMİNALLER

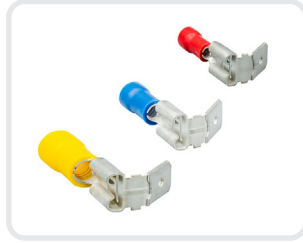

Malzeme : Pirinç, Kalay Kaplı
İzolasyon : PVC
Çalışma Sıcaklığı : Maksimum 75° 600Volt Arası

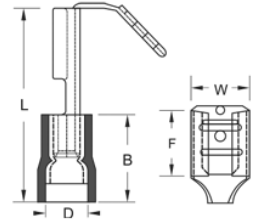

Sipariş Kodu	Ürün Kodu	Renk	Kablo Kesit (mm ²)	Soket Genişliği	Ebatlar (mm)					Kutu Adet	Birim Fiyat TL / Adet
					W	F	L	B	D		
3231	GFDEG - 1861	■ Kırmızı	0.50 - 1.50 mm ²	0.8 x 6.35	6.6	8.0	22.5	10.5	3.8	100	5,10
3232	GFDEG - 2862	■ Mavi	1.50 - 2.50 mm ²	0.8 x 6.35	6.6	8.0	22.5	10.5	4.7	100	5,60
3233	GFDEG - 5866	■ Sarı	4.00 - 6.00 mm ²	0.8 x 6.35	6.6	8.0	24.0	13.0	6.2	100	6,10

ERKEK FASTON TİP TERMİNALLER



Malzeme : Pirinç, Kalay Kaplı
 İzolasyon : PVC
 Çalışma Sıcaklığı : Maksimum 75° 600Volt Arası

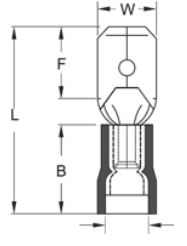

Sipariş Kodu	Ürün Kodu	Renk	Kablo Kesit (mm ²)	Soket Genişliği	Ebatlar (mm)					Kutu Adet	Birim Fiyat TL / Adet
					W	F	L	B	D		
3236	GFE - 1288	Kırmızı	0.50 - 1.50 mm ²	0.8 x 2.80	2.8	6.5	19.2	10.5	3.8	200	1,75
3237	GFE - 1488	Kırmızı		0.8 x 4.75	4.8	6.7	19.8	10.5	3.8	200	2,00
3238	GFE - 1638	Kırmızı		0.8 x 6.35	6.35	6.35	21.8	10.5	3.8	200	2,50
3239	GFE - 2288	Mavi	1.50 - 2.50 mm ²	0.8 x 2.80	2.8	6.7	19.8	10.5	4.7	200	1,75
3240	GFE - 2488	Mavi		0.8 x 4.75	4.8	6.7	19.8	10.5	4.7	200	2,25
3241	GFE - 2638	Mavi		0.8 x 6.35	6.35	7.7	21.8	10.5	4.7	200	2,65
3242	GFE - 5638	Sarı	4.00 - 6.00 mm ²	0.8 x 6.35	6.35	7.7	24.8	13.0	6.2	200	3,10

TAM İZOLELİ POLYAMİD BAYRAK TİP TERMİNALLER





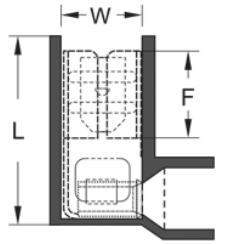





















Malzeme : Pirinç, Kalay Kaplı
 İzolasyon : Polyamid
 Çalışma Sıcaklığı : Maksimum 105° 600Volt Arası



Sipariş Kodu	Ürün Kodu	Renk	Kablo Kesit (mm ²)	Soket Genişliği	Ebatlar (mm)			Kutu Adet	Birim Fiyat TL / Adet
					W	F	L		
3234	GPFDEB - 1861	Kırmızı	1.50 - 2.50 mm ²	0.8 x 6.35	6.6	7.6	16.0	100	7,00
3235	GPFDEB - 2862	Mavi	1.50 - 2.50 mm ²	0.8 x 6.35	6.6	7.6	16.0	100	7,00

İZOLESİZ KABLO UCU VE KONNEKTÖRLERİ

					
Sipariş Kodu	3301	3302	3303	3305	3304
Ürün Kodu	GF1/2D	GFID MİNİ	GFID	GF3D	GF2D TRK
Açıklama	2.8 Mikro Dişi Terminal	4.8 Mini Dişi Terminal	6.3 Dişi Terminal	9.5 Dişi Terminal	6.3 Tırnaklı Dişi Terminal
Kutu Adet	1.000	500	300	100	300
Birim Fiyat TL / Adet	1,20	1,65	2,35	5,75	2,35
					
Sipariş Kodu	3306	3307	3320	3321	3309
Ürün Kodu	GFID EĞRİ	GFID E	GKN 1-03	GKN 1-04	GKN 2.5-04
Açıklama	6.3 Eğri Dişi Terminal	6.3 Erkek Geri Dönüşümlü Terminal	M3 Topraklama Terminali	M4 Topraklama Terminali	M4 Topraklama Terminali
Kutu Adet	250	200	500	500	500
Birim Fiyat TL / Adet	2,80	4,60	1,90	1,90	1,90
					
Sipariş Kodu	3310	3311	3312	3313	3314
Ürün Kodu	GKN 2.5-05	GKN 2.5-06	GKN 4-04	GKN 4-05	GKN 4-06
Açıklama	M5 Topraklama Terminali	M6 Topraklama Terminali	M4 Topraklama Terminali	M5 Topraklama Terminali	M6 Topraklama Terminali
Kutu Adet	500	500	250	250	250
Birim Fiyat TL / Adet	1,90	1,90	4,60	4,60	4,60
					
Sipariş Kodu	3315	3316	3318	3325	3326
Ürün Kodu	GKN 6-06	GKN 8-08	GKN 10-10	GK 2.5	GK 4
Açıklama	M6 Topraklama Terminali	M8 Topraklama Terminali	M10 Topraklama Terminali	Boru Tip Topraklama Terminali	Boru Tip Topraklama Terminali
Kutu Adet	150	150	100	1.000	500
Birim Fiyat TL / Adet	6,00	6,00	7,20	2,40	4,00
					
Sipariş Kodu	3327	3332	3333	3341	3340
Ürün Kodu	GK 6	GFIE ÇK	GFIEU1	R TİPİ KONNEKTÖR	GFID KILIF
Açıklama	Boru Tip Topraklama Terminali	6.3 Erkek Terminal	6.3 Uzun Erkek Terminal	6.3 Kilitli Konnektör	6.3 Terminal Kılıfı
Kutu Adet	250	300	300	300	300
Birim Fiyat TL / Adet	4,30	2,40	3,20	1,45	1,00



İMALATLARIMIZ Ve Bağlantı Elemanları



SKP EKO TİP KABLO PABUCU

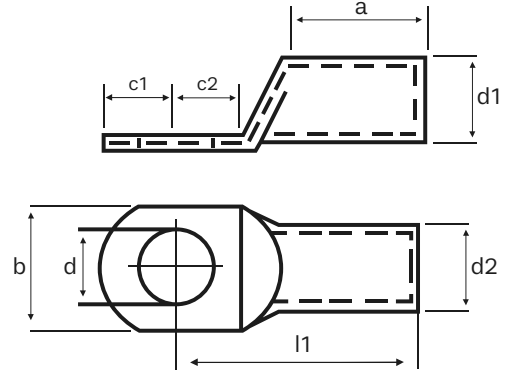

Gwest Eko Tip Kablo Pabuçlarımız;

- EN/13600 standartlarında bakır malzemeden imal edilmiştir.
- Sıkma işlemi yapılırken kırılmayı, sıkma işlemi sonrasında gevşemeyi önlemek için üretim esnasında **tavlı bakır borular** kullanılmıştır.
- Üretimde **%99.9** oranında iletkenliğe sahip bakır kullanılmıştır.
- **5-8 Micron** aralığında **100% Kalay** kaplama yapılmaktadır.

Sipariş Kodu	Ürün Kodu	Kablo Kesit (mm ²)	Delik Çapı Ø	Boyutlar								Kutu Adet	Birim Fiyat TL / Adet
				d	d1	d2	l1	a	b	c1	c2		
3400	SKP-E 16-6	16 mm ²	M6	6,4	5,5	7,0	24,5	11,0	10,5	5,5	6,5	500	20,00
3401	SKP-E 16-8		M8	8,3	5,5	7,0	24,5	11,0	10,5	5,5	6,5	500	20,00
3402	SKP-E 25-6	25 mm ²	M6	6,5	7,0	9,0	31,7	12,0	13,0	6,8	9,2	400	35,00
3403	SKP-E 25-8		M8	8,3	7,0	9,0	31,7	12,0	13,0	6,8	9,2	400	35,00
3404	SKP-E 35-6	35 mm ²	M6	6,5	8,5	10,5	35,2	14,0	15,5	8,3	9,7	300	45,00
3405	SKP-E 35-8		M8	8,3	8,5	10,5	35,2	14,0	15,5	8,3	9,7	300	45,00
3406	SKP-E 50-8	50 mm ²	M8	8,2	10,0	12,0	41,5	17,0	17,9	10,0	12,0	200	58,00
3407	SKP-E 50-10		M10	10,3	10,0	12,0	41,5	17,0	17,9	10,0	12,0	200	58,00
3408	SKP-E 70-10	70 mm ²	M10	10,3	11,5	14,0	45,5	18,0	20,7	10,0	12,0	100	90,00
3409	SKP-E 70-12		M12	13,0	11,5	14,0	45,5	18,0	20,7	10,0	12,0	100	90,00

SKP EKO TİP KABLO PABUCU

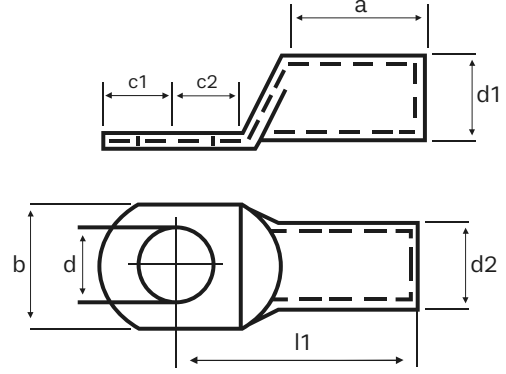

Gwest Eko Tip Kablo Pabuçlarımız;

- EN/13600 standartlarında bakır malzemeden imal edilmiştir.
- Sıkma işlemi yapılırken kırılmayı, sıkma işlemi sonrasında gevşemeyi önlemek için üretim esnasında **tavli bakır borular** kullanılmıştır.
- Üretimde **%99.9** oranında iletkenliğe sahip bakır kullanılmıştır.
- 5-8 Micron aralığında **100% Kalay** kaplama yapılmaktadır.

Sipariş Kodu	Ürün Kodu	Kablo Kesit (mm ²)	Delik Çapı Ø	Boyutlar								Kutu Adet	Birim Fiyat TL / Adet
				d	d1	d2	l1	a	b	c1	c2		
3410	SKP-E 95-10	95 mm ²	M10	10,3	13,5	16,0	48,5	21,0	23,5	10,0	12,0	75	112,00
3411	SKP-E 95-12		M12	12,8	13,5	16,0	48,5	21,0	23,5	10,0	12,0	75	112,00
3412	SKP-E 120-10	120 mm ²	M10	10,5	15,5	18,0	58,0	25,0	26,7	13,0	14,5	50	152,00
3413	SKP-E 120-12		M12	12,8	15,5	18,0	58,0	25,0	26,7	13,0	14,5	50	152,00
3414	SKP-E 150-10	150 mm ²	M10	10,5	16,5	20,0	59,5	26,0	29,2	16,5	16,5	40	270,00
3415	SKP-E 150-12		M12	12,8	16,5	20,0	59,5	26,0	29,2	16,5	16,5	40	270,00
3416	SKP-E 185-12	185 mm ²	M12	10,5	18,5	22,0	65,0	29,0	32,3	17,0	18,0	30	310,00
3417	SKP-E 185-16		M16	16,5	18,5	22,0	65,0	29,0	32,3	17,0	18,0	30	310,00
3418	SKP-E 240-12	240 mm ²	M12	13,0	21,5	25,5	74,0	33,0	37,6	17,0	18,0	25	425,00
3419	SKP-E 240-16		M16	16,5	21,5	25,5	74,0	33,0	37,6	17,0	18,0	25	425,00

SKP STANDART TİP KABLO PABUCU

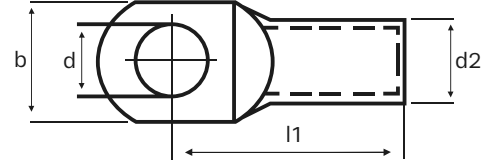
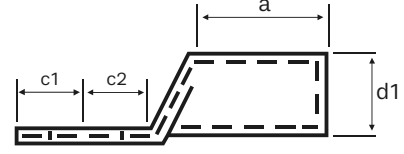

Gwest Standart Tip Kablo Pabuçlarımız;

- EN/13600 standartlarında bakır malzemeden imal edilmiştir.
- Sıkma işlemi yapılırken kırılmayı, sıkma işlemi sonrasında gevşemeyi önlemek için üretim esnasında **tavlı bakır borular** kullanılmıştır.
- Üretimde **%99.9** oranında iletkenliğe sahip bakır kullanılmıştır.
- **5-8 Micron** aralığında **100% Kalay** kaplama yapılmaktadır.

Sipariş Kodu	Ürün Kodu	Kablo Kesit (mm ²)	Delik Çapı Ø	Boyutlar								Kutu Adet	Birim Fiyat TL / Adet
				d	d1	d2	l1	a	b	c1	c2		
3430	SKP-S 10-5	10 mm ²	M5	5,5	4,7	6,6	22,0	10,0	10,3	5,5	7,0	1.000	20,00
3431	SKP-S 10-6		M6	6,5	4,7	6,6	22,0	10,0	10,3	5,5	7,0	1.000	20,00
3432	SKP-S 10-8		M8	8,5	4,7	6,6	23,7	10,0	13,5	6,8	8,7	1.000	20,00
3433	SKP-S 16-6	16 mm ²	M6	6,5	5,6	7,8	24,0	12,0	11,2	5,5	6,5	500	28,00
3434	SKP-S 16-8		M8	8,5	5,6	7,8	26,2	12,0	13,5	6,8	8,7	500	30,00
3435	SKP-S 16-10		M10	10,5	5,6	7,8	26,0	12,0	16,0	7,5	8,5	500	30,00
3436	SKP-S 25-6	25 mm ²	M6	6,5	7,1	9,5	32,2	16,0	13,7	6,8	9,2	400	48,00
3437	SKP-S 25-8		M8	8,5	7,1	9,5	32,2	16,0	13,7	6,8	9,2	400	48,00
3438	SKP-S 25-10		M10	10,5	7,1	9,5	34,0	16,0	16,0	8,0	11,0	300	52,00
3439	SKP-S 35-6	35 mm ²	M6	6,5	8,2	10,8	35,7	19,0	15,3	8,3	9,7	200	69,00
3440	SKP-S 35-8		M8	8,5	8,2	10,8	35,7	19,0	15,3	8,3	9,7	200	69,00
3441	SKP-S 35-10		M10	10,5	8,2	10,8	38,0	19,0	15,7	10,0	12,0	200	73,00
3391	SKP-S 35-12		M12	13,0	8,2	10,8	38,0	19,0	18,0	10,0	12,0	150	73,00
3389	SKP-S 50-6	50 mm ²	M6	6,5	10,1	13,0	39,2	21,0	18,9	8,3	9,7	150	100,00
3442	SKP-S 50-8		M8	8,5	10,1	13,0	39,2	21,0	18,9	8,3	9,7	150	100,00
3443	SKP-S 50-10		M10	10,5	10,1	13,0	41,5	21,0	18,9	10,0	12,0	150	105,00
3444	SKP-S 50-12		M12	13,0	10,1	13,0	41,5	21,0	18,9	10,0	12,0	150	105,00
3446	SKP-S 70-8	70 mm ²	M8	8,5	11,5	14,7	42,3	23,0	21,1	8,3	9,7	100	143,00
3447	SKP-S 70-10		M10	10,5	11,5	14,7	44,6	23,0	21,1	10,0	12,0	100	143,00
3448	SKP-S 70-12		M12	13,0	11,5	14,7	44,6	23,0	21,1	10,0	12,0	100	143,00
3449	SKP-S 70-14		M14	15,0	11,5	14,7	47,6	23,0	21,5	15,0	15,0	100	160,00
3392	SKP-S 70-16		M16	17,0	11,5	14,7	47,6	23,0	21,5	15,0	15,0	100	160,00

SKP STANDART TİP KABLO PABUCU

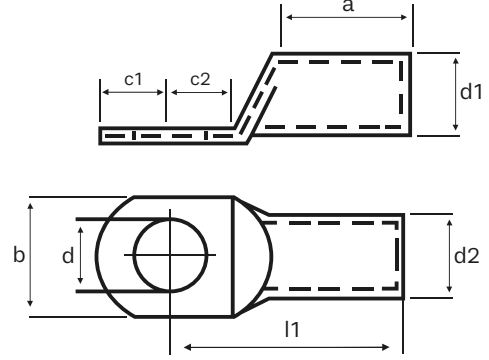

Gwest Standart Tip Kablo Pabuçlarımız;

- EN/13600 standartlarında bakır malzemeden imal edilmiştir.
- Sıkma işlemi yapılırken kırılmayı, sıkma işlemi sonrasında gevşemeyi önlemek için üretim esnasında **tavlı bakır borular** kullanılmıştır.
- Üretimde **%99.9** oranında iletkenliğe sahip bakır kullanılmıştır.
- **5-8 Micron** aralığında **100% Kalay** kaplama yapılmaktadır.

Sipariş Kodu	Ürün Kodu	Kablo Kesit (mm ²)	Delik Çapı Ø	Boyutlar								Kutu Adet	Birim Fiyat TL / Adet
				d	d1	d2	l1	a	b	c1	c2		
3450	SKP-S 95-8	95 mm ²	M8	8,5	13,5	16,7	48,8	26,0	24,7	10,0	12,0	75	175,00
3451	SKP-S 95-10		M10	10,5	13,5	16,7	48,8	26,0	24,7	10,0	12,0	75	175,00
3452	SKP-S 95-12		M12	13,0	13,5	16,7	48,8	26,0	24,7	10,0	12,0	75	175,00
3453	SKP-S 120-10	120 mm ²	M10	10,5	15,6	19,0	56,0	29,0	27,7	13,0	14,5	50	242,00
3454	SKP-S 120-12		M12	13,0	15,6	19,0	56,0	29,0	27,7	13,0	14,5	50	242,00
3393	SKP-S 120-14		M14	15,0	15,6	19,0	56,0	29,0	27,7	13,0	14,5	50	242,00
3455	SKP-S 120-16		M16	17,0	15,6	19,0	56,0	29,0	27,7	13,0	14,5	50	242,00
3456	SKP-S 150-10	150 mm ²	M10	10,5	16,5	21,0	60,0	30,0	30,4	16,5	16,5	40	390,00
3457	SKP-S 150-12		M12	13,0	16,5	21,0	60,0	30,0	30,4	16,5	16,5	40	390,00
3394	SKP-S 150-14		M14	15,0	16,5	21,0	60,0	30,0	30,4	16,5	16,5	40	390,00
3458	SKP-S 150-16		M16	17,0	16,5	21,0	60,0	30,0	30,4	16,5	16,5	40	390,00
3395	SKP-S 185-10	185 mm ²	M10	10,5	18,4	23,0	65,5	33,0	34,2	17,0	18,0	30	480,00
3459	SKP-S 185-12		M12	13,0	18,4	23,0	65,5	33,0	34,2	17,0	18,0	30	480,00
3396	SKP-S 185-14		M14	15,0	18,4	23,0	65,5	33,0	34,2	17,0	18,0	30	480,00
3460	SKP-S 185-16		M16	17,0	18,4	23,0	65,5	33,0	34,2	17,0	18,0	30	480,00
3397	SKP-S 240-10	240 mm ²	M10	10,5	21,0	26,0	72,0	38,0	38,7	17,0	18,0	25	630,00
3461	SKP-S 240-12		M12	13,0	21,0	26,0	72,0	38,0	38,7	17,0	18,0	25	630,00
3398	SKP-S 240-14		M14	15,0	21,0	26,0	72,0	38,0	38,7	17,0	18,0	25	630,00
3462	SKP-S 240-16		M16	17,0	21,0	26,0	72,0	38,0	38,7	17,0	18,0	25	630,00
3399	SKP-S 300-12	300 mm ²	M12	13,0	23,4	28,6	77,0	41,0	42,6	18,0	18,0	20	750,00
3463	SKP-S 300-14		M14	15,0	23,4	28,6	77,0	41,0	42,6	18,0	18,0	20	750,00
3464	SKP-S 300-16		M16	17,0	23,4	28,6	77,0	41,0	42,6	18,0	18,0	20	750,00

DIN 46235 TİPİ KABLO PABUCU



- EN/13600 standartlarında bakır malzemeden imal edilmiştir.
- Sıkma işlemi yapılırken kırılmayı, sıkma işlemi sonrasında gevşemeyi önlemek için üretim esnasında **tavlı bakır borular** kullanılmıştır.
- Üretimde **%99.9** oranında iletkenliğe sahip bakır kullanılmıştır.
- **5-8 Micron** aralığında **100% Kalay** kaplama yapılmaktadır.

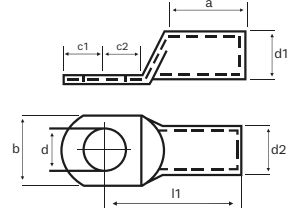

Sipariş Kodu	Ürün Kodu	Kablo Kesit (mm ²)	Delik Çapı Ø	Boyutlar (mm)								Kutu Adet	Birim Fiyat TL / Adet
				d	d1	d2	l1	a	b	c1	c2		
7000	SKP-D 10-5	10 mm ²	M5	5,3	4,5	7,0	27,0	10,0	9,0	7,0	8,5	500	25,00
7001	SKP-D 10-6		M6	6,4	4,5	7,0	27,0	10,0	9,0	7,5	8,5		
7002	SKP-D 16-6	16 mm ²	M6	6,4	5,5	8	36	20	13	7	8	250	60,00
7003	SKP-D 16-8		M8	8,4	5,5	8,5	36,0	20,0	13,0	10,0	10,0		
7004	SKP-D 16-10		M10	10,5	5,5	8,5	36,0	20,0	17,0	12,0	12,0		
7005	SKP-D 25-6	25 mm ²	M6	6,4	7,0	10,0	38,0	20,0	14,0	7,5	8,0	200	82,00
7006	SKP-D 25-8		M8	8,4	7,0	10,0	38,0	20,0	16,0	10,0	10,0		
7007	SKP-D 25-10		M10	10,5	7,0	10,0	38,0	20,0	17,0	12,0	12,0		
7008	SKP-D 25-12		M12	13,0	7,0	10,0	38,0	20,0	19,0	13,0	13,0		
7009	SKP-D 35-8	35 mm ²	M8	8,4	8,2	12,5	42,0	20,0	17,0	10,0	10,0	120	150,00
7010	SKP-D 35-10		M10	10,5	8,2	12,5	42,0	20,0	19,0	12,0	12,0		
7011	SKP-D 35-12		M12	13,0	8,2	12,5	42,0	20,0	21,0	13,0	13,0		
7012	SKP-D 50-8	50 mm ²	M8	8,4	10,0	14,5	52,0	28,0	20,0	10,0	10,0	65	190,00
7013	SKP-D 50-10		M10	10,5	10,0	14,5	52,0	28,0	22,0	12,0	12,0		
7014	SKP-D 50-12		M12	13,0	10,0	14,5	52,0	28,0	24,0	13,0	13,0		
7015	SKP-D 50-16		M16	17,0	10,0	14,5	52,0	28,0	28,0	16,0	16,0		
7016	SKP-D 70-8	70 mm ²	M8	8,4	11,5	16,5	55,0	28,0	24,0	10,0	10,0	50	290,00
7017	SKP-D 70-10		M10	10,5	11,5	16,5	55,0	28,0	24,0	12,0	12,0		
7018	SKP-D 70-12		M12	13,0	11,5	16,5	55,0	28,0	24,0	13,0	13,0		
7019	SKP-D 70-16		M16	17,0	11,5	16,5	55,0	28,0	30,0	16,0	16,0		

DIN 46235 TİPİ KABLO PABUCU



- EN/13600 standartlarında bakır malzemeden imal edilmiştir.
- Sıkma işlemi yapılırken kırılmayı, sıkma işlemi sonrasında gevşemeyi önlemek için üretim esnasında tavlı bakır borular kullanılmıştır.
- Üretimde %99.9 oranında iletkenliğe sahip bakır kullanılmıştır.
- 5-8 Micron aralığında 100% Kalay kaplama yapılmaktadır.

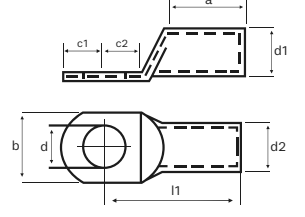

Sipariş Kodu	Ürün Kodu	Kablo Kesit (mm ²)	Delik Çapı Ø	Boyutlar (mm)								Kutu Adet	Birim Fiyat TL / Adet
				d	d1	d2	l1	a	b	c1	c2		
7020	SKP-D 95-10	95 mm ²	M10	10,5	13,5	19,0	65,0	35,0	28,0	12,0	12,0	30	430,00
7021	SKP-D 95-12		M12	13,0	13,5	19,0	65,0	35,0	28,0	13,0	13,0	30	430,00
7022	SKP-D 95-16		M16	17,0	13,5	19,0	65,0	35,0	32,0	16,0	16,0	30	430,00
7023	SKP-D 120-10	120 mm ²	M10	10,5	15,5	21,0	70,0	35,0	32,0	15,0	16,0	25	530,00
7024	SKP-D 120-12		M12	13,0	15,5	21,0	70,0	35,0	32,0	16,0	17,0	25	530,00
7025	SKP-D 120-16		M16	17,0	15,5	21,0	70,0	35,0	32,0	19,0	20,0	25	530,00
7026	SKP-D 120-20		M20	21,0	15,5	21,0	70,0	35,0	38,0	21,0	22,0	25	530,00
7027	SKP-D 150-10	150 mm ²	M10	10,5	17,0	23,5	78,0	35,0	34,0	15,0	16,0	20	760,00
7028	SKP-D 150-12		M12	13,0	17,0	23,5	78,0	35,0	34,0	16,0	17,0	20	760,00
7029	SKP-D 150-16		M16	17,0	17,0	23,5	78,0	35,0	34,0	19,0	20,0	20	760,00
7030	SKP-D 150-20		M20	21,0	17,0	23,5	78,0	35,0	40,0	21,0	22,0	20	760,00
7031	SKP-D 185-10	185 mm ²	M10	10,5	19,0	25,5	82,0	40,0	37,0	15,0	16,0	15	870,00
7032	SKP-D 185-12		M12	13,0	19,0	25,5	82,0	40,0	37,0	16,0	17,0	15	870,00
7033	SKP-D 185-16		M16	17,0	19,0	25,5	82,0	40,0	37,0	19,0	20,0	15	870,00
7034	SKP-D 185-20		M20	21,0	19,0	25,5	82,0	40,0	40,0	21,0	22,0	15	870,00
7035	SKP-D 240-12	240 mm ²	M12	13,0	21,5	29,0	92,0	40,0	42,0	16,0	17,0	10	1.250,00
7036	SKP-D 240-16		M16	17,0	21,5	29,0	92,0	40,0	42,0	19,0	20,0	10	1.250,00
7037	SKP-D 240-20		M20	21,0	21,5	29,0	92,0	40,0	45,0	21,0	22,0	10	1.250,00
7038	SKP-D 300-16	300 mm ²	M16	17,0	24,5	32,0	100,0	50,0	48,0	19,0	22,0	10	1.600,00
7039	SKP-D 300-20		M20	21,0	24,5	32,0	100,0	50,0	48,0	22,0	22,0	10	1.600,00

KAYNAKLI TİP KABLO PABUCU



- EN61238 standartlarında bakır malzemeden imal edilmiştir.
- Sıkma işlemi yapılırken kırılmayı, sıkma işlemi sonrasında gevşemeyi önlemek için üretim esnasında **tavlı bakır borular** kullanılmıştır.
- Üretimde %99.9 oranında iletkenliğe sahip bakır kullanılmıştır.
- 5-8 Micron aralığında 100% Kalay kaplama yapılmaktadır.

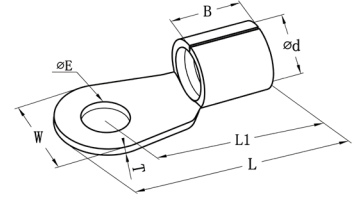

Sipariş Kodu	Ürün Kodu	Kablo Kesit (mm ²)	Delik Çapı Ø	Boyutlar (mm)							Kutu Adet	Birim Fiyat TL / Adet
				E	d	W	B	L1	L	T		
7101	SKP-KT 1-4	22-16 A.W.G 0,5 - 1,5 mm ²	M4	4,3	1,6	8	5	12	16	0,8	7.000	4,50
7102	SKP-KT 1-5		M5	5,3		10		13	18		6.000	5,20
7103	SKP-KT 1-6		M6	6,5		11		16	21,5		4.000	5,90
7105	SKP-KT 2,5-4	16-14 A.W.G 1,5 - 2,5 mm ²	M4	4,3	2,3	8	5	12	16	0,8	6.000	4,70
7106	SKP-KT 2,5-5		M5	5,3		10		14	19		5.000	6,00
7107	SKP-KT 2,5-6		M6	6,5		11		16	21,5		4.000	6,70
7109	SKP-KT 6-4	12-10 A.W.G 4-6 mm ²	M4	4,3	3,6	8	6	14	18	1	2.500	8,50
7110	SKP-KT 6-5		M5	5,3		10		15	20		2.500	9,70
7111	SKP-KT 6-6		M6	6,5		11		16	21,5		2.500	10,40
7112	SKP-KT 6-8		M8	8,4		14		19	26		2.000	13,20
7113	SKP-KT 6-10		M10	10,5		18		21	30		1.500	18,50
7115	SKP-KT 10-6	8 A.W.G 10 mm ²	M6	6,5	4,5	11	8	17	22,5	1,1	2.000	14,80
7116	SKP-KT 10-8		M8	8,4		14		20	27		1.500	17,50
7117	SKP-KT 10-10		M10	10,5		18		21	30		1.000	21,50
7120	SKP-KT 16-6	6 A.W.G 16 mm ²	M6	6,5	5,8	11	10	20	25,5	1,2	800	22,50
7121	SKP-KT 16-8		M8	8,4		14		22	29		800	25,00
7122	SKP-KT 16-10		M10	10,5		18		24	33		700	30,00
7125	SKP-KT 25-6	4 A.W.G 25 mm ²	M6	6,5	7,5	12	11	25	31	1,5	600	42,00
7126	SKP-KT 25-8		M8	8,4		16		25	33		600	45,00
7127	SKP-KT 25-10		M10	10,5		18		26	35		600	47,00
7130	SKP-KT 35-6	2 A.W.G 35 mm ²	M6	6,5	9	15	12	26	33,5	1,6	400	57,00
7131	SKP-KT 35-8		M8	8,4		16		26	34		400	57,00
7132	SKP-KT 35-10		M10	10,5		18		27	36		400	60,00
7133	SKP-KT 35-12		M12	13		22		31	42		400	69,00



KAYNAKLI TİP KABLO PABUCU



- EN61238 standartlarında bakır malzemeden imal edilmiştir.
- Sıkma işlemi yapılırken kırılmayı, sıkma işlemi sonrasında gevşemeyi önlemek için üretim esnasında **tavlı bakır borular** kullanılmıştır.
- Üretimde **%99.9** oranında iletkenliğe sahip bakır kullanılmıştır.
- 5-8 Micron aralığında **100% Kalay** kaplama yapılmaktadır.

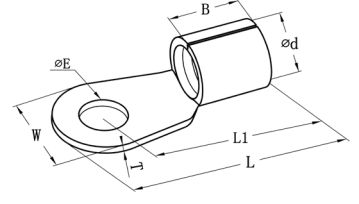

Sipariş Kodu	Ürün Kodu	Kablo Kesit (mm ²)	Delik Çapı Ø	Boyutlar (mm)							Kutu Adet	Birim Fiyat TL / Adet			
				E	d	W	B	L1	L	T					
7136	SKP-KT 50-8	1/0 A.W.G 50 mm ²	M8	8,4	11	18	16	34	43	1,8	200	100,00			
7137	SKP-KT 50-10		M10	10,5		18		34	43		200	100,00			
7138	SKP-KT 50-12		M12	13		22		36	47		200	105,00			
7141	SKP-KT 70-8	2/0 A.W.G 70 mm ²	M8	8,4	13	22	18	38	49	2	150	150,00			
7142	SKP-KT 70-10		M10	10,5							150	150,00			
7143	SKP-KT 70-12		M12	13							150	150,00			
7145	SKP-KT 95-8	3/0 A.W.G 95 mm ²	M8	8,4	15	24	20	42	54	2,5	80	240,00			
7146	SKP-KT 95-10		M10	10,5							80	240,00			
7147	SKP-KT 95-12		M12	13							80	240,00			
7149	SKP-KT 120-8	4/0 A.W.G 120 mm ²	M8	8,4	16,5	24	22	44	56	3	60	330,00			
7150	SKP-KT 120-10		M10	10,5							60	330,00			
7151	SKP-KT 120-12		M12	13							60	330,00			
7152	SKP-KT 120-16		M16	17							28	48	62	60	330,00
7154	SKP-KT 150-10	250/300 MCM 150 mm ²	M10	10,5	19	30	24	50	65	3,2	50	470,00			
7155	SKP-KT 150-12		M12	13							50	65	3,2	50	470,00
7156	SKP-KT 150-16		M16	17							50	65	3,2	50	470,00
7159	SKP-KT 185-12	300/350 MCM 185 mm ²	M12	13	21	36	28	50	68	3,5	50	630,00			
7160	SKP-KT 185-16		M16	17							50	68	3,5	50	630,00
7163	SKP-KT 240-12	400/500 MCM 240 mm ²	M12	13	23,5	38	32	56	75	4	30	900,00			
7164	SKP-KT 240-16		M16	17							30	900,00			

DAR GİRİŞLİ KABLO PABUCU



- EN61238 standartlarında bakır malzemeden imal edilmiştir.
- Sıkma işlemi yapılırken kırılmayı, sıkma işlemi sonrasında gevşemeyi önlemek için üretim esnasında **tavli bakır borular** kullanılmıştır.
- Üretimde %99.9 oranında iletkenliğe sahip bakır kullanılmıştır.
- 5-8 Micron aralığında **100% Kalay** kaplama yapılmaktadır.

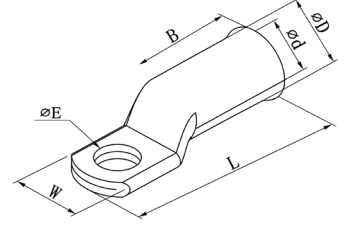

Sipariş Kodu	Ürün Kodu	Kablo Kesit (mm ²)	Delik Çapı Ø	Boyutlar (mm)						Kutu Adet	Birim Fiyat TL / Adet
				E	D	d	W	B	L		
7165	SKP-DG 35-6	2 AWG 35 mm ²	M6	6,6	11,2	8,2	15	21	41	250	115,00
7166	SKP-DG 50-6	1/0 AWG 50 mm ²	M6	6,6	12,8	9,5	15	22	43	200	150,00
7167	SKP-DG 50-10		M10	11			19				
7169	SKP-DG 70-8	2/0 AWG 70 mm ²	M8	8,8	14,7	11,2	19	24	51	125	210,00
7170	SKP-DG 70-10		M10	11						125	210,00
7171	SKP-DG 95-8	3/0 AWG 95 mm ²	M8	8,8	17,4	13,4	19	27	51	72	300,00
7172	SKP-DG 95-10		M10	11						55	72
7173	SKP-DG 120-8	4/0 AWG 120 mm ²	M8	8,8	20,6	15,6	19	30	61	56	470,00
7174	SKP-DG 120-10		M10	11						56	470,00
7175	SKP-DG 120-12		M12	13						56	470,00
7176	SKP-DG 150-8	250/300 MCM 150 mm ²	M8	8,8	22,5	16,7	19	30	66	40	600,00
7177	SKP-DG 150-10		M10	11						40	600,00
7178	SKP-DG 185-10	300/350 MCM 185 mm ²	M10	11	24,2	18,4	24,5	32	74	28	750,00
7179	SKP-DG 185-12		M12	13						28	750,00
7180	SKP-DG 240-10	400/500 MCM 240 mm ²	M10	11	28,2	21,2	31	38	82	20	1.200,00
7181	SKP-DG 240-12		M12	13,2						20	1.200,00

90° AÇILI KABLO PABUCU



- EN61238 standartlarında bakır malzemeden imal edilmiştir.
- Sıkma işlemi yapılırken kırılmayı, sıkma işlemi sonrasında gevşemeyi önlemek için üretim esnasında **tavlı bakır borular** kullanılmıştır.
- Üretimde **%99.9** oranında iletkenliğe sahip bakır kullanılmıştır.
- 5-8 Micron aralığında **100% Kalay** kaplama yapılmaktadır.

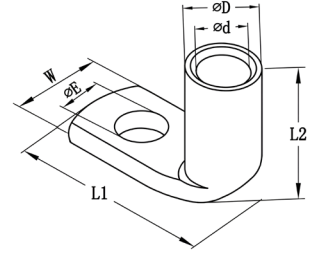

Sipariş Kodu	Ürün Kodu	Kablo Kesit (mm ²)	Delik Çapı Ø	Boyutlar (mm)						Kutu Adet	Birim Fiyat TL / Adet
				E	D	d	W	L2	L1		
7234	SKP-DE 10-5	8 A.W.G 10 mm ²	M5	5,3	7	4,5	12	16	23	800	45,00
7235	SKP-DE 10-6		M6	6,4			12		24	800	45,00
7236	SKP-DE 10-8		M8	8,4			15		28	600	50,00
7239	SKP-DE 16-6	6 A.W.G 16 mm ²	M6	6,4	8,5	5,5	14	20	24	600	70,00
7240	SKP-DE 16-8		M8	8,4			15		28	500	70,00
7241	SKP-DE 16-10		M10	10,5			18		31	400	75,00
7244	SKP-DE 25-6	4 A.W.G 25 mm ²	M6	6,4	10	6,9	15	21	27,5	300	90,00
7245	SKP-DE 25-8		M8	8,4			16		32,5	300	95,00
7246	SKP-DE 25-10		M10	10,5			18		32,5	300	95,00
7248	SKP-DE 35-6	2 A.W.G 35 mm ²	M6	6,4	12	8,5	17	24	28,5	250	135,00
7249	SKP-DE 35-8		M8	8,4			17		34	250	140,00
7250	SKP-DE 35-10		M10	10,5			20		34	200	140,00
7253	SKP-DE 50-8	1/0 A.W.G 50 mm ²	M8	8,4	14	10	20	28,5	40,5	150	230,00
7254	SKP-DE 50-10		M10	10,5			20		40,5	150	230,00
7255	SKP-DE 50-12		M12	13			23		42,5	100	230,00
7258	SKP-DE 70-8	2/0 A.W.G 70 mm ²	M8	8,4	16,5	12	24	31	43	100	350,00
7259	SKP-DE 70-10		M10	10,5					43	100	350,00
7260	SKP-DE 70-12		M12	13					44,5	100	350,00
7263	SKP-DE 95-8	3/0 A.W.G 95 mm ²	M8	8,4	18	13,5	26	35	44,5	75	450,00
7264	SKP-DE 95-10		M10	10,5					44,5	75	450,00
7265	SKP-DE 95-12		M12	13					46,5	75	450,00
7270	SKP-DE 120-10	4/0 A.W.G 120 mm ²	M10	10,5	19,5	15	29	35,5	49	75	480,00
7271	SKP-DE 120-12		M12	13					49	75	480,00
7276	SKP-DE 150-10	250/300 MCM 150 mm ²	M10	10,5	21	16,5	31	40	48	50	570,00
7277	SKP-DE 150-12		M12	13					51	50	570,00
7279	SKP-DE 150-16		M16	17					56	40	570,00
7281	SKP-DE 185-10	300/350 MCM 185 mm ²	M10	10,5	24	19	35	46	58,5	40	800,00
7282	SKP-DE 185-12		M12	13					58,5	40	800,00
7283	SKP-DE 185-16		M16	17					58,5	40	800,00
7285	SKP-DE 240-12	400/500 MCM 240 mm ²	M12	13	26	21	40	50	54	30	930,00
7286	SKP-DE 240-16		M16	17					60	30	930,00

45° AÇILI KABLO PABUCU



- EN61238 standartlarında bakır malzemeden imal edilmiştir.
- Sıkma işlemi yapılırken kırılmayı, sıkma işlemi sonrasında gevşemeyi önlemek için üretim esnasında **tavli bakır borular** kullanılmıştır.
- Üretimde %99.9 oranında iletkenliğe sahip bakır kullanılmıştır.
- 5-8 Micron aralığında **100% Kalay** kaplama yapılmaktadır.

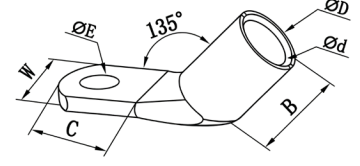

Sipariş Kodu	Ürün Kodu	Kablo Kesit (mm ²)	Delik Çapı Ø	Boyutlar (mm)						Kutu Adet	Birim Fiyat TL / Adet
				E	D	d	W	B	C		
7185	SKP-DE 10-5	8 A.W.G 10 mm ²	M5	5,3			11,9	11,5	12,5	800	32,00
7186	SKP-DE 10-6		M6	6,4	6,9	4,7	11,9	11	12,5	800	32,00
7187	SKP-DE 10-8		M8	8,3			13,5	11	15,5	800	32,00
7190	SKP-DE 16-6	6 A.W.G 16 mm ²	M6	6,4			11,9		11,5	600	36,00
7191	SKP-DE 16-8		M8	8,3	7,8	5,6	13,5	12	15	600	36,00
7192	SKP-DE 16-10		M10	10,5			16		16	400	36,00
7193	SKP-DE 25-6	4 A.W.G 25 mm ²	M6	6,4			14		16	400	60,00
7194	SKP-DE 25-8		M8	8,3	9,5	7,1	14	13	16	400	60,00
7195	SKP-DE 25-10		M10	10,5			16		19	400	60,00
7196	SKP-DE 35-6	2 A.W.G 35 mm ²	M6	6,4					18	300	95,00
7197	SKP-DE 35-8		M8	8,3	11	8,2	16,5	16	18	300	95,00
7198	SKP-DE 35-10		M10	10,5					22	300	95,00
7200	SKP-DE 50-8	1/0 A.W.G 50 mm ²	M8	8,3				20	18	160	140,00
7201	SKP-DE 50-10		M10	10,5	12,5	9,5	18	19	22	200	140,00
7202	SKP-DE 50-12		M12	13,2				20	22	160	140,00
7203	SKP-DE 70-8	2/0 A.W.G 70 mm ²	M8	8,3					18	120	210,00
7204	SKP-DE 70-10		M10	10,5	15	11,5	21,5	20	22	120	210,00
7205	SKP-DE 70-12		M12	13,2					22	120	210,00
7206	SKP-DE 95-8	3/0 A.W.G 95 mm ²	M8	8,3						80	260,00
7207	SKP-DE 95-10		M10	10,5	17	13,5	24,7	22	21,8	80	260,00
7208	SKP-DE 95-12		M12	13,2						80	260,00
7211	SKP-DE 120-10	4/0 A.W.G 120 mm ²	M10	10,5						50	440,00
7212	SKP-DE 120-12		M12	13,2	20	15,6	29	27	32,5	50	440,00
7215	SKP-DE 150-10	250/300 MCM 150 mm ²	M10	10,5						40	530,00
7216	SKP-DE 150-12		M12	13	21	16,5	30,4	32	33	40	530,00
7218	SKP-DE 150-16		M16	16,5						40	530,00
7220	SKP-DE 185-10	300/350 MCM 185 mm ²	M10	10,5						30	700,00
7221	SKP-DE 185-12		M12	13,2	23,6	18,4	34	34	35	30	700,00
7223	SKP-DE 185-16		M16	16,5						30	700,00
7224	SKP-DE 240-12	400/500 MCM 240 mm ²	M12	13,2				37		25	850,00
7226	SKP-DE 240-16		M16	16,5	26,4	21,2	38,5	38	35	25	850,00



BİMETAL (AL-CU) KABLO PAPUCU

Malzeme : %99,9 Alüminyum ve Bakır
Çekme Derecesi : 110MPa
Çalışma Sıcaklığı : - 40 ° C --- +100 ° C

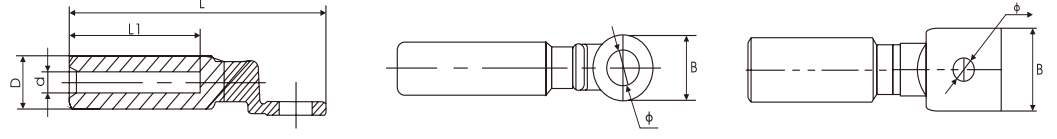

Sipariş Kodu	Ürün Kodu	Kablo Kesit (mm ²)	Delik Çapı Ø	Boyutlar (mm)					Kutu Adet	Koli Adet	Birim Fiyat TL / Adet
				d	D	L1	L	B			
7050	SKP-BM 16-10	16 mm ²	M10	6	16	41	82	24	100	600	150,00
7051	SKP-BM 25-10	25 mm ²	M10	7	16	41	82	24	100	600	150,00
7052	SKP-BM 35-10	35 mm ²	M10	8,5	16	41	82	24	100	600	150,00
7053	SKP-BM 50-12	50 mm ²	M12	9,8	20	49	90	25	50	300	200,00
7054	SKP-BM 70-12	70 mm ²	M12	11,6	20	49	90	25	50	300	200,00
7055	SKP-BM 95-12	95 mm ²	M12	13,8	20	49	90	25	50	300	200,00
7056	SKP-BM 120-12	120 mm ²	M12	15,5	25	60	113	28	30	180	310,00
7057	SKP-BM 150-12	150 mm ²	M12	17	25	60	113	28	30	180	310,00
7058	SKP-BM 185-12	185 mm ²	M12	18,5	32	65	130	35	20	120	570,00
7059	SKP-BM 240-12	240 mm ²	M12	21,5	32	65	130	35	20	120	570,00
7060	SKP-BM 300-12	300 mm ²	M12	24	34	70,8	135	36	15	90	610,00
7061	SKP-BM 400-16	400 mm ²	M16	26	34	70,8	135	36	9	54	900,00



BİMETAL (CAL) KABLO PAPUCU

Malzeme : %99,9 Alüminyum ve Bakır
Çekme Derecesi : 110MPa
Çalışma Sıcaklığı : - 40 ° C --- +100 ° C

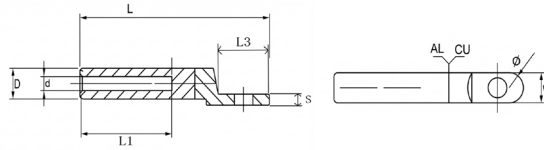

Sipariş Kodu	Ürün Kodu	Kablo Kesit (mm ²)	Delik Çapı Ø	Boyutlar (mm)					Kutu Adet	Koli Adet	Birim Fiyat TL / Adet
				d	D	L1	L	W			
7062	SKP-CAL 16-8	16 mm ²	M8	6	16	38	80	14	100	600	155,00
7063	SKP-CAL 25-8	25 mm ²	M8	7	16	38	80	14	100	600	155,00
7064	SKP-CAL 35-8	35 mm ²	M8	8,5	16	38	80	14	100	600	155,00
7065	SKP-CAL 50-8	50 mm ²	M8	9,8	20	43	89	16	50	300	220,00
7066	SKP-CAL 70-8	70 mm ²	M8	11,6	20	43	89	16	50	300	220,00
7067	SKP-CAL 95-8	95 mm ²	M8	13,8	20	43	89	16	50	300	220,00
7068	SKP-CAL 120-10	120 mm ²	M10	15,5	25	60	114	19	30	180	335,00
7069	SKP-CAL 150-10	150 mm ²	M10	17	25	60	114	19	30	180	335,00
7070	SKP-CAL 185-10	185 mm ²	M10	18,5	32	60	125	21	20	120	580,00
7071	SKP-CAL 240-10	240 mm ²	M10	21,5	32	60	125	21	20	120	580,00

EK MUF

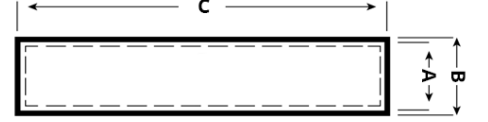

Gwest Ek Muflarımız;

- EN/13600 standartlarında bakır malzemeden imal edilmiştir.
- Sıkma işlemi yapılırken kırılmayı, sıkma işlemi sonrasında gevşemeyi önlemek için üretim esnasında **tavlı bakır borular** kullanılmıştır.
- Üretimde **%99.9** oranında iletkenliğe sahip bakır kullanılmıştır.
- **5-8 Micron** aralığında **100% Kalay** kaplama yapılmaktadır.

Sipariş Kodu	Ürün Kodu	Kablo Kesit (mm ²)	Boyutlar (mm)			Kutu Adet	Birim Fiyat TL / Adet
			A	B	C		
3465	EKMUF - 10	10	4,7	6,6	30,0	1.000	21,00
3466	EKMUF - 16	16	5,5	7,0	35,0	500	22,00
3467	EKMUF - 25	25	7,0	9,0	40,0	300	38,00
3468	EKMUF - 35	35	8,5	10,5	45,0	200	50,00
3469	EKMUF - 50	50	10,0	12,0	50,0	100	55,00
3470	EKMUF - 70	70	11,5	14,0	55,0	75	80,00
3471	EKMUF - 95	95	13,5	16,0	60,0	50	105,00
3472	EKMUF - 120	120	15,5	18,0	65,0	50	130,00
3473	EKMUF - 150	150	16,5	20,0	70,0	30	230,00
3474	EKMUF - 185	185	18,5	22,0	75,0	25	280,00
3475	EKMUF - 240	240	21,5	25,5	85,0	20	385,00
3476	EKMUF - 300	300	23,5	28,5	100,0	15	800,00

DIN 46235 TİP EK MUF

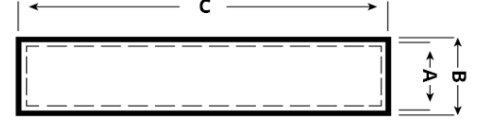

Gwest DIN 46235 Tip Ek Muflarımız;

- EN/13600 standartlarında bakır malzemeden imal edilmiştir.
- Sıkma işlemi yapılırken kırılmayı, sıkma işlemi sonrasında gevşemeyi önlemek için üretim esnasında **tavlı bakır borular** kullanılmıştır.
- Üretimde **%99.9** oranında iletkenliğe sahip bakır kullanılmıştır.
- **5-8 Micron** aralığında **100% Kalay** kaplama yapılmaktadır.

Sipariş Kodu	Ürün Kodu	Kablo Kesit (mm ²)	Boyutlar (mm)			Kutu Adet	Birim Fiyat TL / Adet
			A	B	C		
3477	EKMUF D - 10	10	4,5	7,0	30,0	300	25,00
3478	EKMUF D - 16	16	5,5	8,0	50,0	200	60,00
3479	EKMUF D - 25	25	7,0	10,0	50,0	150	80,00
3480	EKMUF D - 35	35	8,2	12,5	50,0	100	150,00
3481	EKMUF D - 50	50	10,0	14,5	56,0	60	175,00
3482	EKMUF D - 70	70	11,5	16,5	56,0	50	270,00
3483	EKMUF D - 95	95	13,5	19,0	70,0	30	370,00
3484	EKMUF D - 120	120	15,5	21,0	70,0	25	440,00
3485	EKMUF D - 150	150	17,0	23,5	80,0	20	630,00
3486	EKMUF D - 185	185	19,0	25,5	85,0	15	730,00
3487	EKMUF D - 240	240	21,5	29,0	90,0	10	1.000,00
3488	EKMUF D - 300	300	24,5	32,0	100,0	10	1.250,00

DELİKLİ MONTAJ RAYLARI

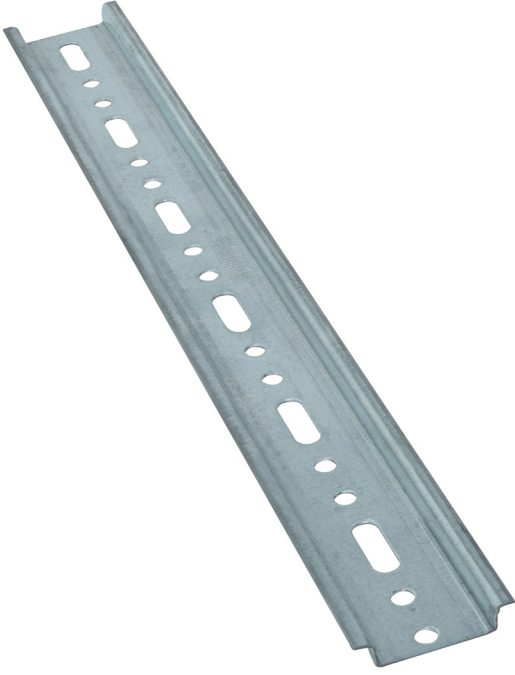

Malzeme : Galvaniz Kaplama
Dış Genişlik : 35mm
İç Genişlik : 27mm
Derinlik : 7,5mm



Sipariş Kodu	Ürün Kodu	Uzunluk	Kutu Adet	Birim Fiyat TL / Adet
3494	GW - MR 030	30 cm	150	22,00
3495	GW - MR 1	1 m	50	60,00
3496	GW - MR 2	2 m	30	120,00

DÜZ MONTAJ RAYLARI



Malzeme : Galvaniz Kaplama
Dış Genişlik : 35mm
İç Genişlik : 27mm
Derinlik : 7,5mm



Sipariş Kodu	Ürün Kodu	Uzunluk	Kutu Adet	Birim Fiyat TL / Adet
3497	GW - MRD 030	30 cm	150	22,00
3498	GW - MRD 1	1 m	50	60,00
3499	GW - MRD 2	2 m	30	120,00

MONOFAZE MÜŞTEREK W OTOMAT BARALARI

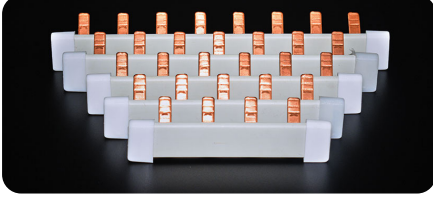

Sipariş Kodu	Ürün Kodu	Bakır Kalınlığı	Boy	Modül	Amper	Kutu Adet	Fiyat TL / Adet
3599	M - 5308	0.8 mm	53 cm	30 Otomat için	63 A	60	240,00
3600	M - 10608	0.8 mm	106 cm	60 Otomat için	63 A	60	480,00
3601	M - 531	1 mm	53 cm	30 Otomat için	80 A	60	300,00
3602	M - 1061	1 mm	106 cm	60 Otomat için	80 A	60	600,00
3603	M - 5315	1.5 mm	53 cm	30 Otomat için	100 A	60	450,00
3604	M - 10615	1.5 mm	106 cm	60 Otomat için	100 A	60	900,00

TRİFAZE MÜŞTEREK W OTOMAT BARALARI

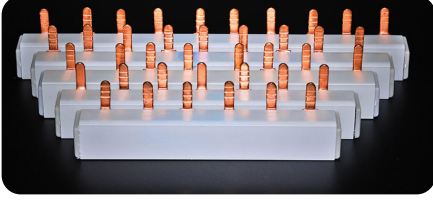

Sipariş Kodu	Ürün Kodu	Bakır Kalınlığı	Boy	Modül	Amper	Kutu Adet	Fiyat TL / Adet
3632	T - 5308	0.8 mm	53 cm	10 Grup için	63 A	24	750,00
3633	T - 10608	0.8 mm	106 cm	20 Grup için	63 A	24	1.500,00
3608	T - 531	1 mm	53 cm	10 Grup için	80 A	24	900,00
3609	T - 1061	1 mm	106 cm	20 Grup için	80 A	24	1.800,00
3613	T - 5315	1,5 mm	53 cm	10 Grup için	100 A	24	1.350,00
3614	T - 10615	1,5 mm	106 cm	20 Grup için	100 A	24	2.700,00
3627	Gwest - KAP			Monofaze Bara Kapağı		60	10,00
3628	Gwest - KAP			Trifaze Bara Kapağı		60	10,00

2 KUTUPLU DAĞITICI ÜNİTELER

Birim Fiyat TL / Adet	370,00	
Sipariş Kodu	3701	
Ürün Kodu	GW - 2x7	
Akım	125 Amper	
Kablo Cinsi	Tek Damar	Çok Telli
Kablo Kesit (mm ²)	Giriş	Çıkış
	1x10-35 mm ²	1x10-25 mm ² 5x2,5-6 mm ²
	1x10-16 mm ²	1x6-16 mm ² 5x1,5-6 mm ²
Ambalaj Adet	Paket	Koli
	1	138

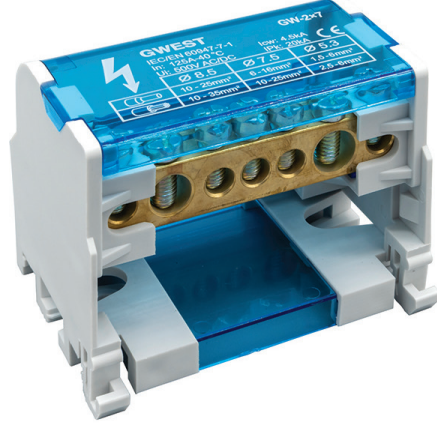

Birim Fiyat TL / Adet	530,00	
Sipariş Kodu	3702	
Ürün Kodu	GW - 2x11	
Akım	125 Amper	
Kablo Cinsi	Tek Damar	Çok Telli
Kablo Kesit (mm ²)	Giriş	Çıkış
	2x10-35 mm ²	2x10-25 mm ² 7x2,5-6 mm ²
	2x10-16 mm ²	2x6-16 mm ² 7x1,5-6 mm ²
Ambalaj Adet	Paket	Koli
	1	84

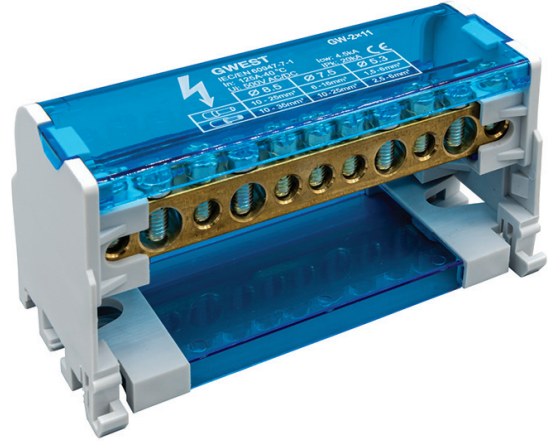

Birim Fiyat TL / Adet	680,00	
Sipariş Kodu	3703	
Ürün Kodu	GW - 2x15	
Akım	125 Amper	
Kablo Cinsi	Tek Damar	Çok Telli
Kablo Kesit (mm ²)	Giriş	Çıkış
	2x10-35 mm ²	2x10-25 mm ² 11x2,5-6 mm ²
	2x10-16 mm ²	2x6-16 mm ² 11x1,5-6 mm ²
Ambalaj Adet	Paket	Koli
	1	72

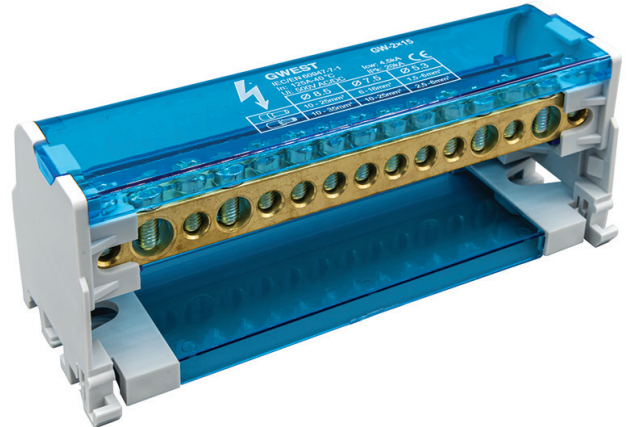

4 KUTUPLU DAĞITICI ÜNİTELER

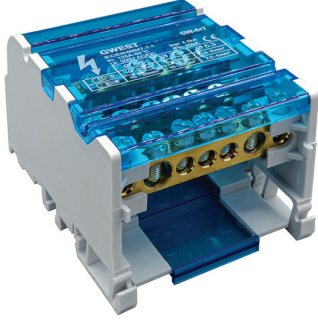

Birim Fiyat TL / Adet	680,00	
Sipariş Kodu	3704	
Ürün Kodu	GW - 4x7	
Akım	125 Amper	
Kablo Cinsi	Tek Damar	Çok Tellî
Kablo Kesit (mm ²)	Giriş	Çıkış
	1x10-35 mm ²	1x10-25 mm ² 5x2,5-6 mm ²
	1x10-16 mm ²	1x6-16 mm ² 5x1,5-6 mm ²
Ambalaj Adet	Paket	Koli
	1	74

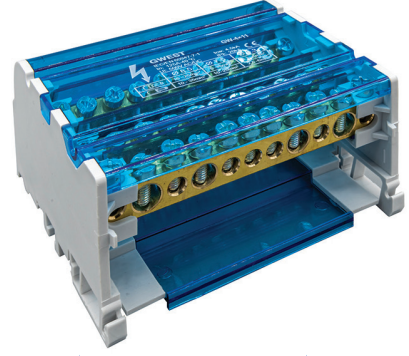

Birim Fiyat TL / Adet	1.000,00	
Sipariş Kodu	3705	
Ürün Kodu	GW - 4x11	
Akım	125 Amper	
Kablo Cinsi	Tek Damar	Çok Tellî
Kablo Kesit (mm ²)	Giriş	Çıkış
	2x10-35 mm ²	2x10-25 mm ² 7x2,5-6 mm ²
	2x10-16 mm ²	2x6-16 mm ² 7x1,5-6 mm ²
Ambalaj Adet	Paket	Koli
	1	50

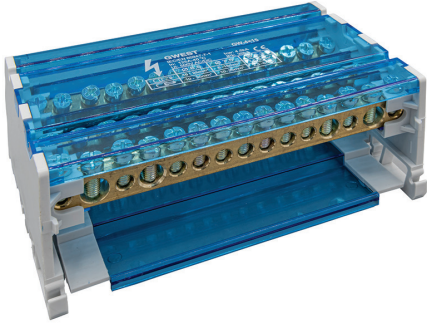

Birim Fiyat TL / Adet	1.250,00	
Sipariş Kodu	3706	
Ürün Kodu	GW - 4x15	
Akım	125 Amper	
Kablo Cinsi	Tek Damar	Çok Tellî
Kablo Kesit (mm ²)	Giriş	Çıkış
	2x10-35 mm ²	2x10-25 mm ² 11x2,5-6 mm ²
	2x10-16 mm ²	2x6-16 mm ² 11x1,5-6 mm ²
Ambalaj Adet	Paket	Koli
	1	40

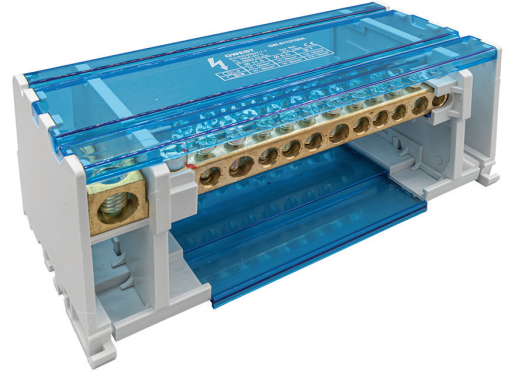

Birim Fiyat TL / Adet	3.100,00	
Sipariş Kodu	3707	
Ürün Kodu	GW - 4x12/160A	
Akım	160 Amper	
Kablo Cinsi	Tek Damar	Çok Tellî
Kablo Kesit (mm ²)	Giriş	Çıkış
	1x10-50 mm ²	3x10-35 mm ² 8x2,5-16 mm ²
	1x10-50 mm ²	3x6-25 mm ² 8x1,5-16 mm ²
Ambalaj Adet	Paket	Koli
	1	18

TEK KUTUPLU DAĞITICI ÜNİTELER



Birim Fiyat TL / Adet	310,00	
Sipariş Kodu	3708	
Ürün Kodu	GW - 80A	
Akım	80 Amper	
Kablo Kesit (mm ²)	Giriş	Çıkış
	1x10-16 mm ²	4x2,5-6 mm ² 2x2,5-16 mm ²
Ambalaj Adet	Paket	Koli
	5	250



Birim Fiyat TL / Adet	640,00	
Sipariş Kodu	3709	
Ürün Kodu	GW - 125A	
Akım	125 Amper	
Kablo Kesit (mm ²)	Giriş	Çıkış
	1x10-35 mm ²	6x2,5-16 mm ² Köprü 1x6-16 mm ²
Ambalaj Adet	Paket	Koli
	5	160



Birim Fiyat TL / Adet	660,00	
Sipariş Kodu	3710	
Ürün Kodu	GW - 160A	
Akım	160 Amper	
Kablo Kesit (mm ²)	Giriş	Çıkış
	1x10-70 mm ²	6x2,5-16 mm ² Köprü 1x6-16 mm ²
Ambalaj Adet	Paket	Koli
	5	160



Birim Fiyat TL / Adet	1.900,00	
Sipariş Kodu	3711	
Ürün Kodu	GW - 250A	
Akım	250 Amper	
Kablo Kesit (mm ²)	Giriş	Çıkış
	1x35-120 mm ²	4x2,5-10 mm ² 5x2,5-16 mm ² 2x6-35 mm ²
Ambalaj Adet	Paket	Koli
	3	54

TEK KUTUPLU DAĞITICI ÜNİTELER



Birim Fiyat TL / Adet	2.000,00	
Sipariş Kodu	3712	
Ürün Kodu	GW - 400A	
Akım	400 Amper	
Kablo Kesit (mm ²)	Giriş	Çıkış
	1x95-185 mm ²	4x2,5-10 mm ² 5x2,5-16 mm ² 2x6-35 mm ²
Ambalaj Adet	Paket	Koli
	3	54

Birim Fiyat TL / Adet	2.150,00	
Sipariş Kodu	3713	
Ürün Kodu	GW - 500A	
Akım	500 Amper	
Kablo Kesit (mm ²)	Giriş	Çıkış
	8x24 mm ²	4x2,5-10 mm ² 5x2,5-16 mm ² 2x6-35 mm ²
Ambalaj Adet	Paket	Koli
	3	54

SKP BAĞLANTILI DAĞITICI ÜNİTELER

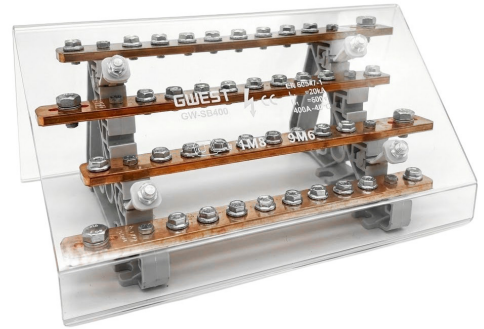
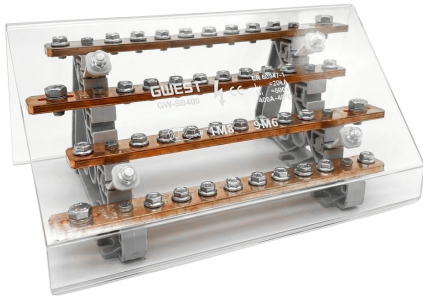

Birim Fiyat TL / Adet	4.200,00	
Sipariş Kodu	3714	
Ürün Kodu	GW-SB250	
Akım	250 Amper	
Vida Boyutu	9M6+1M8	
Ambalaj Adet	Paket	Koli
	1	8

Birim Fiyat TL / Adet	5.800,00	
Sipariş Kodu	3715	
Ürün Kodu	GW-SB400	
Akım	400 Amper	
Vida Boyutu	9M6+1M8	
Ambalaj Adet	Paket	Koli
	1	6



KOMPAKT KLEMENSLER

Geçmeli ve Çok Amaçlı



www.guvenelektrik.com.tr

GEÇMELİ BUAT KLEMENSLER

	Sipariş Kodu	Ürün Kodu	Renk	Kablo Kesiti	Ebatlar			Ambalaj Adet		Birim Fiyat TL / Adet
					En	Boy	Yükseklik	Paket	Koli	
	3501	GW 2,5 - 2	Beyaz	0,50 - 2,5 mm ²	9.8	16.4	5.8	200	10.000	6,00
	3502	GW 2,5 - 3	Turuncu	0,50 - 2,5 mm ²	13.9	16.4	5.8	200	10.000	6,20
	3503	GW 2,5 - 4	Kırmızı	0,50 - 2,5 mm ²	17.9	16.4	5.8	100	5.000	7,20
	3504	GW 2,5 - 5	Sarı	0,50 - 2,5 mm ²	21.9	16.4	5.8	100	5.000	8,40
	3505	GW 2,5 - 6	Kırmızı	0,50 - 2,5 mm ²	13.8	16.4	11.25	100	5.000	11,50
	3506	GW 2,5 - 8	Gri	0,50 - 2,5 mm ²	17.8	16.4	11.25	100	5.000	13,00

Çalışma Sıcaklığı: -30°C + 100°C

Nominal Akım : 24A

Nominal Gerilim : 250V

ÇOK AMAÇLI KLEMENSLER



	Sipariş Kodu	Ürün Kodu	Kablo Kesiti	Açıklama	Ambalaj Adet		Birim Fiyat TL / Adet
					Paket	Koli	
	3507	GW - 412	0,20 - 4,0 mm ²	2 İletken Bağlantılı	100	5.000	11,50
	3508	GW - 413	0,20 - 4,0 mm ²	3 İletken Bağlantılı	100	5.000	15,00
	3509	GW - 414	0,20 - 4,0 mm ²	4 İletken Bağlantılı	50	2.500	18,00
	3510	GW - 415	0,20 - 4,0 mm ²	5 İletken Bağlantılı	50	2.500	21,50

Çalışma Sıcaklığı: -40°C + 105°C





Nominal Akım : 24A

Nominal Gerilim : 250V

RAY MONTAJLI KLEMENSLER

	Sipariş Kodu	Ürün Kodu	Tek Telli Kablo Kesiti mm ²	Çok Telli Kablo Kesiti mm ²	Ambalaj Adet		Birim Fiyat TL / Adet
					Paket	Koli	
	3511	GW-4F	0.5-4mm ² 20-12AWG	0.5-2.5mm ² 20-14AWG	40	2.000	66,00
	3512	GW-6F	0.5-6mm ² 20-10AWG	0.5-4mm ² 20-12AWG	36	1.800	84,00
Çalışma Sıcaklığı: -40°C + 105°C			Nominal Akım : 32A - 40A		Nominal Gerilim : 450V		

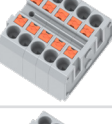
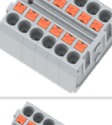
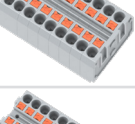
(2.5mm²) DAĞITIM BLOĞU

	Sipariş Kodu	Ürün Kodu	Kablo Kesiti mm ²	Ambalaj Adet		Birim Fiyat TL / Adet
				Paket	Koli	
	3513	GW C2.5-6	0.5-2.5mm ² 20-14AWG	30	1.500	85,00
	3514	GW C2.5-8	0.5-2.5mm ² 20-14AWG	18	900	110,00
	3515	GW C2.5-10	0.5-2.5mm ² 20-14AWG	18	900	140,00
	3516	GW C2.5-12	0.5-2.5mm ² 20-14AWG	25	1250	170,00
	3517	GW C2.5-18	0.5-2.5mm ² 20-14AWG	12	600	260,00
	3518	GW C2.5-24	0.5-2.5mm ² 20-14AWG	10	500	350,00
Çalışma Sıcaklığı: -40°C + 105°C			Nominal Akım : 32A		Nominal Gerilim : 450V	

(2.5mm²) RAY MONTAJLI DAĞITIM BLOĞU

	Sipariş Kodu	Ürün Kodu	Kablo Kesiti mm ²	Ambalaj Adet		Birim Fiyat TL / Adet
				Paket	Koli	
	3519	GW C2.5-12A	0.5-2.5mm ² 20-14AWG	15	750	180,00
	3520	GW C2.5-18A	0.5-2.5mm ² 20-14AWG	8	400	265,00
	3521	GW C2.5-24A	0.5-2.5mm ² 20-14AWG	8	400	350,00

Çalışma Sıcaklığı: -40°C + 105°C

Nominal Akım : 32A

Nominal Gerilim : 450V

6mm² BESLEME GİRİŞLİ (2.5mm²) DAĞITIM BLOĞU

	Sipariş Kodu	Ürün Kodu	Besleme Girişi Kablo Kesiti mm ²	Kablo Kesiti mm ²	Ambalaj Adet		Birim Fiyat TL / Adet
					Paket	Koli	
	3522	GW6 S2.5-6	0.5-6mm ² 20-10AWG	0.5-2.5mm ² 20-14AWG	18	900	165,00
	3523	GW6 S2.5-12	0.5-6mm ² 20-10AWG	0.5-2.5mm ² 20-14AWG	12	600	250,00
	3524	GW6 S2.5-18	0.5-6mm ² 20-12AWG	0.5-2.5mm ² 20-14AWG	8	400	330,00
	3525	GW6 S2.5-24	0.5-6mm ² 20-12AWG	0.5-2.5mm ² 20-14AWG	8	400	410,00

Çalışma Sıcaklığı: -40°C + 105°C

Nominal Akım : 32A

Nominal Gerilim : 450V

RAY MONTAJ AYAĞI

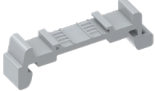
	Sipariş Kodu	Ürün Kodu	Ürün Açıklaması	Ambalaj Adet		Birim Fiyat TL / Adet
				Paket	Koli	
	3526	GW-RA	Ray Montaj Ayağı	1000	5.000	8,50



MAKARON GRUBU Ve Kablo orabı



ISI İLE DARALAN SİYAH MAKARONLAR

TEKNİK ÖZELLİKLER



Malzeme : Polyolefin Daralma Oranı : 2/1 Voltaj: 600V Yanmazlık : Kendi kendine söner Çalışma Sıcaklığı : -45°C -- +125°C

Sipariş Kodu	Ölçü		Daralmadan Önce (mm)		Daralmadan Sonra (mm)		Makara / Mt.	Koli Miktarı	Birim Fiyat USD / Mt.
	Inch	mm	İç Çap	Cidar Kalınlığı	İç Çap	Cidar Kalınlığı			
4015	—	1	2,0 ± 0,3	0,16 ± 0,05	0,70	0,30 ± 0,05	200	3.200	0,085
4016	—	1,5	2,0 ± 0,3	0,16 ± 0,05	0,80	0,30 ± 0,05	200	2.400	0,097
4017	—	2	2,5 ± 0,3	0,16 ± 0,05	1,00	0,35 ± 0,05	200	3.000	0,115
4003	3/32	2,4	3,0 ± 0,3	0,16 ± 0,05	1,50	0,35 ± 0,05	200	3.000	0,115
4018	—	2,5	3,0 ± 0,3	0,16 ± 0,05	1,25	0,38 ± 0,05	200	2.600	0,15
4019	—	3	3,5 ± 0,4	0,20 ± 0,05	1,50	0,38 ± 0,05	200	2.200	0,16
4004	1/8	3,2	3,5 ± 0,4	0,20 ± 0,05	1,75	0,40 ± 0,05	200	2.200	0,16
4020	—	3,5	4,0 ± 0,4	0,20 ± 0,05	1,75	0,40 ± 0,05	200	1.800	0,17
4021	—	4	4,5 ± 0,4	0,20 ± 0,05	2,00	0,45 ± 0,05	200	1.400	0,20
4022	—	4,5	4,8 ± 0,4	0,20 ± 0,05	2,00	0,47 ± 0,08	200	1.200	0,23
4005	3/16	4,8	5,2 ± 0,4	0,20 ± 0,05	2,60	0,47 ± 0,08	200	1.200	0,23
4023	—	5	5,5 ± 0,4	0,20 ± 0,05	2,50	0,55 ± 0,08	200	1.000	0,25
4024	—	6	6,5 ± 0,4	0,22 ± 0,05	3,00	0,55 ± 0,08	200	800	0,29
4006	1/4	6,4	7,0 ± 0,4	0,28 ± 0,05	3,50	0,55 ± 0,08	200	800	0,29
4025	—	7	7,5 ± 0,4	0,28 ± 0,05	3,50	0,60 ± 0,08	100	500	0,35
4026	—	8	8,5 ± 0,4	0,30 ± 0,08	4,00	0,60 ± 0,08	100	1.300	0,35
4007	3/8	9,5	10,0 ± 0,5	0,30 ± 0,08	5,00	0,60 ± 0,08	100	1.200	0,35
4028	—	10	10,0 ± 0,5	0,30 ± 0,08	5,00	0,60 ± 0,08	100	1.100	0,39
4008	1/2	12,7	13,0 ± 0,5	0,33 ± 0,10	6,50	0,65 ± 0,08	100	1.000	0,45
4031	—	13	13,5 ± 0,5	0,33 ± 0,10	6,50	0,65 ± 0,08	100	900	0,48
4032	—	14	14,5 ± 0,5	0,33 ± 0,10	7,00	0,70 ± 0,08	100	900	0,56
4034	4/5	16	16,5 ± 0,6	0,35 ± 0,12	8,00	0,75 ± 0,08	100	800	0,75
4036	—	18	19,0 ± 0,6	0,40 ± 0,15	9,00	0,80 ± 0,15	100	700	0,98
4009	3/4	19,1	20,5 ± 0,6	0,40 ± 0,15	10,00	0,80 ± 0,15	100	700	0,98
4038	—	20	20,5 ± 0,6	0,40 ± 0,15	10,00	0,80 ± 0,15	100	600	1,25
4039	—	22	22,5 ± 0,7	0,45 ± 0,15	12,00	0,95 ± 0,15	100	600	1,55
4010	1	25,4	25,6 ± 0,7	0,45 ± 0,15	12,00	0,95 ± 0,15	50	300	1,65
4040	—	30	31,5 ± 0,7	0,50 ± 0,15	15,00	0,95 ± 0,15	50	250	2,15
4011	1-1/4	32	33,0 ± 0,7	0,50 ± 0,15	16,50	0,95 ± 0,15	50	250	2,15
4041	—	35	38,0 ± 0,7	0,50 ± 0,15	16,00	1,00 ± 0,15	50	200	2,70
4012	1-1/2	38	40,0 ± 0,7	0,50 ± 0,15	20,00	1,00 ± 0,15	50	200	3,00
4042	—	40	40,5 ± 0,7	0,50 ± 0,15	20,00	1,00 ± 0,15	50	200	3,00
4013	2	51	52,5 ± 0,7	0,50 ± 0,15	25,00	1,00 ± 0,15	25	125	3,80
4043	—	60	60,5 ± 0,8	0,52 ± 0,15	30,00	1,00 ± 0,16	25	100	5,10
4044	—	70	70,5 ± 1,0	0,55 ± 0,15	40,00	1,10 ± 0,18	25	75	6,80
4045	—	80	82,0 ± 1,0	0,55 ± 0,15	40,00	1,10 ± 0,18	25	75	7,50
4050	—	90	90,0 ± 1,0	0,55 ± 0,15	45,00	1,10 ± 0,18	25	50	8,50
4046	4	102	105,0 ± 1,0	0,55 ± 0,15	51,00	1,10 ± 0,18	25	50	9,50
4047	—	120	120,0 ± 1,0	0,55 ± 0,15	60,00	1,10 ± 0,18	25	50	13,00
4048	—	150	150,0 ± 1,0	0,55 ± 0,15	76,00	1,10 ± 0,18	25	50	19,00
4049	—	180	180,0 ± 1,0	0,55 ± 0,15	90,00	1,10 ± 0,18	25	25	27,00

ISI İLE DARALAN RENKLİ MAKARONLAR

ŞEFFAF - BEYAZ - KIRMIZI - MAVİ - SARI - YEŞİL - GRİ

Ölçü		Sipariş Kodu							Makara / Mt.	Koli Miktarı	Birim Fiyat USD / Mt.
Inch	mm	ŞEFFAF	BEYAZ	KIRMIZI	MAVİ	SARI	YEŞİL	GRİ			
—	1,5	4201	4289	4219	4237	4254	4272	4306	200	3.200	0,11
—	2,5	4202	4290	4220	4238	4256	4273	4307	200	2.600	0,17
1/8	3,2	4203	4291	4221	4239	4257	4274	4308	200	2.200	0,20
—	3,5	—	4292	—	—	4258	—	—	200	1.800	0,21
Yassı	3,5	—	4395	—	—	4390	—	—	100	1.600	0,21
3/16	4,8	4204	4293	4222	4240	4259	4275	4309	100	1.000	0,27
Yassı	4,8	—	4396	—	—	4391	—	—	100	1.500	0,27
1/4	6,4	4205	4294	4224	4241	4260	4276	4310	100	700	0,33
Yassı	6,4	—	4397	—	—	4392	—	—	100	1.500	0,33
Yassı	7	—	4398	—	—	4393	—	—	100	1.400	0,33
3/8	9,5	4206	4295	4226	4242	4261	4278	4311	100	1.200	0,39
—	13	4208	4296	4227	4243	4262	4279	4312	100	900	0,55
4/5	16	4209	4297	4228	4244	4263	4280	4313	100	800	0,85
—	20	4210	4298	4229	4245	4264	4281	4314	100	600	1,50
1	25,4	4211	4299	4230	4246	4265	4282	4315	50	300	1,90
1 - 1/4	32	4212	4300	4231	4247	4266	4283	4316	50	250	2,40
1 - 1/2	38	4213	4301	4232	4248	4267	4284	4317	50	200	3,60
2	51	4214	4302	4233	4249	4268	4285	4318	25	125	4,20
—	60	4215	4303	4234	4250	4269	4286	4319	25	100	5,80
—	80	4216	4304	4235	4251	4270	4287	4320	25	75	8,00
4	102	4217	4305	4236	4252	4271	4288	4321	25	50	11,00



TEKNİK ÖZELLİKLER

- Malzeme : Polyolefin
- Daralma Oranı : 2/1
- Yanmazlık : Kendi kendine söner
- Çalışma Sıcaklığı : -45°C -- +125°C
- Voltaj : 600V



ISI İLE DARALAN RENKLİ MAKARONLAR KAHVERENGİ

Sipariş Kodu	Ölçü		Daralmadan Önce (mm)		Daralmadan Sonra (mm)		Makara / Mt.	Koli Miktarı	Birim Fiyat USD / Mt.
	Inch	mm	İç Çap	Cidar Kalınlığı	İç Çap	Cidar Kalınlığı			
4322	—	1,5	2,0 ± 0,3	0,16 ± 0,05	0,80	0,30 ± 0,05	200	3.200	0,12
4323	—	2,5	3,0 ± 0,3	0,16 ± 0,05	1,25	0,38 ± 0,05	200	2.600	0,18
4324	1/8	3,2	3,5 ± 0,4	0,20 ± 0,05	1,75	0,40 ± 0,05	200	2.200	0,22
4325	3/16	4,8	5,2 ± 0,4	0,20 ± 0,05	2,60	0,47 ± 0,08	100	1.000	0,29
4326	1/4	6,4	7,0 ± 0,4	0,28 ± 0,05	3,50	0,55 ± 0,08	100	700	0,38
4327	3/8	9,5	10,0 ± 0,5	0,30 ± 0,08	5,00	0,60 ± 0,08	100	1.200	0,44
4328	—	13	13,5 ± 0,5	0,33 ± 0,10	6,50	0,65 ± 0,08	100	900	0,60
4329	4/5	16	16,5 ± 0,6	0,35 ± 0,12	8,00	0,75 ± 0,08	100	800	1,05
4330	—	20	20,5 ± 0,6	0,40 ± 0,15	10,00	0,80 ± 0,15	100	600	1,55
4331	1	25,4	25,6 ± 0,7	0,45 ± 0,15	12,00	0,95 ± 0,15	50	300	2,10
4332	1-1/4	32	33,0 ± 0,7	0,50 ± 0,15	16,50	0,95 ± 0,15	50	250	2,80
4333	1-1/2	38	40,0 ± 0,7	0,50 ± 0,15	20,00	1,00 ± 0,15	50	200	4,10
4334	2	51	52,5 ± 0,7	0,50 ± 0,15	25,00	1,00 ± 0,15	25	125	4,90
4335	—	60	60,5 ± 0,8	0,52 ± 0,15	30,00	1,00 ± 0,16	25	100	7,50
4336	—	80	82,0 ± 1,0	0,55 ± 0,15	40,00	1,10 ± 0,18	25	75	9,00
4337	4	102	105,0 ± 1,0	0,55 ± 0,15	51,00	1,10 ± 0,18	25	50	13,50



TEKNİK ÖZELLİKLER

- Malzeme : Polyolefin
- Daralma Oranı : 2/1
- Yanmazlık : Kendi kendine söner
- Çalışma Sıcaklığı : -45°C -- +125°C
- Voltaj : 600V



ISI İLE DARALAN RENKLİ MAKARONLAR

SARI YEŞİL

Sipariş Kodu	Ölçü		Daralmadan Önce (mm)		Daralmadan Sonra (mm)		Makara / Mt.	Koli Miktarı	Birim Fiyat USD / Mt.
	Inch	mm	İç Çap	Cidar Kalınlığı	İç Çap	Cidar Kalınlığı			
4102	3/32	2,4	3,0 ± 0,3	0,16 ± 0,05	1,50	0,35 ± 0,05	200	3.000	0,42
4103	1/8	3,2	3,5 ± 0,4	0,20 ± 0,05	1,75	0,40 ± 0,05	200	2.200	0,43
4104	3/16	4,8	5,2 ± 0,4	0,20 ± 0,05	2,60	0,47 ± 0,08	100	1.000	0,44
4105	1/4	6,4	7,0 ± 0,4	0,28 ± 0,05	3,50	0,55 ± 0,08	100	700	0,50
4106	3/8	9,5	10,0 ± 0,5	0,30 ± 0,08	5,00	0,60 ± 0,08	100	1.200	0,68
4107	—	13	13,5 ± 0,5	0,33 ± 0,10	6,50	0,65 ± 0,08	100	900	1,00
4108	4/5	16	16,5 ± 0,6	0,35 ± 0,12	8,00	0,75 ± 0,08	100	800	1,45
4109	—	20	20,5 ± 0,6	0,40 ± 0,15	10,00	0,80 ± 0,15	100	600	1,90
4110	1	25,4	25,6 ± 0,7	0,45 ± 0,15	12,00	0,95 ± 0,15	50	300	2,75
4111	1 - 1/4	32	33,0 ± 0,7	0,50 ± 0,15	16,50	0,95 ± 0,15	50	250	3,70
4112	1 - 1/2	38	40,0 ± 0,7	0,50 ± 0,15	20,00	1,00 ± 0,15	50	200	5,00
4113	2	51	52,5 ± 0,7	0,50 ± 0,15	25,00	1,00 ± 0,15	50	125	7,00
4114	—	60	60,5 ± 0,8	0,52 ± 0,15	30,00	1,00 ± 0,16	25	100	10,00
4115	—	80	82,0 ± 1,0	0,55 ± 0,15	40,00	1,10 ± 0,18	25	75	15,00
4116	4	102	105,0 ± 1,0	0,55 ± 0,15	51,00	1,10 ± 0,18	25	50	23,00

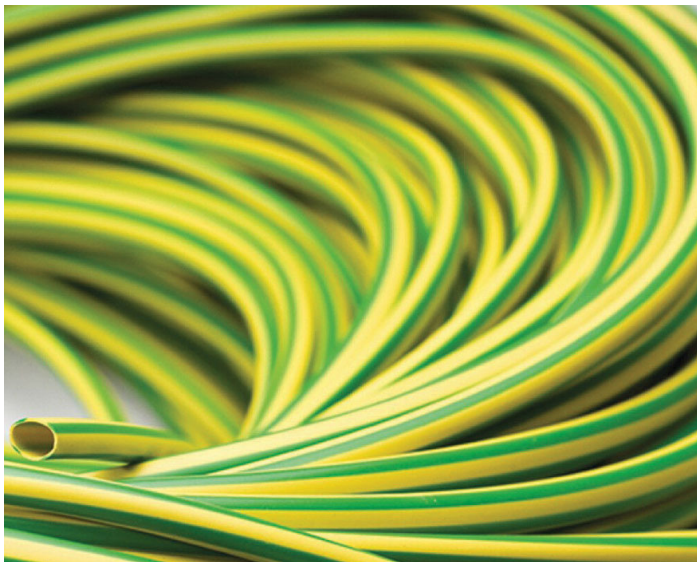

TEKNİK ÖZELLİKLER

- Malzeme : Polyolefin
- Daralma Oranı : 2/1
- Yanmazlık : Kendi kendine söner
- Çalışma Sıcaklığı : -45°C -- +125°C
- Voltaj : 600V



İÇİ YAPIŞKANLI DARALAN MAKARONLAR

Sipariş Kodu	Ölçü (mm)	Daralmadan Önce (mm)	Daralmadan Sonra (mm)			Makara / Mt.	Koli Miktarı	Birim Fiyat USD / Mt.
		İç Çap	İç Çap	Anma Çıdar Kalınlığı	Anma Yaişkanlığı			
4418	3/1	3.2	1	0.90 ± 0.30	0.50	200	1800	0,65
4419	4.8/1.6	4.8	1.6	1.05 ± 0.30	0.50	100	900	0,80
4420	6/2	6.4	2.2	1.25 ± 0.30	0.50	100	600	1,20
4421	9/3	9.5	3.2	1.45 ± 0.30	0.60	50	300	1,60
4422	12.7/4	12.7	4.2	1.65 ± 0.30	0.60	25	250	2,00
4424	16/5	16	5.2	1.80 ± 0.30	0.60	25	225	2,40
4423	19/6	19.1	6.3	1.95 ± 0.30	0.60	25	175	3,50
4405	12/4	12	4	1.40 ± 0.20	0.80	1.20 Boy	250	2,30
4406	16/5	16	5	1.50 ± 0.20	0.80	1.20 Boy	250	3,20
4407	19/6	19	6	1.80 ± 0.20	0.80	1.20 Boy	150	4,50
4408	28/9	28	9	2.40 ± 0.30	1.05	1.20 Boy	110	5,10
4409	33/10	33	10	2.50 ± 0.30	1.05	1.20 Boy	100	5,80
4410	40/12	40	12	2.40 ± 0.30	1.05	1.20 Boy	70	6,40
4411	45/14	45	14	2.40 ± 0.30	1.05	1.20 Boy	60	7,10
4412	55/16	55	18	2.40 ± 0.30	1.05	1.20 Boy	50	8,00
4414	70/25	70	25	2.90 ± 0.30	1.35	1.20 Boy	32	11,30
4415	90/30	90	30	3.00 ± 0.30	1.35	1.20 Boy	24	16,00
4416	125/40	125	40	3.00 ± 0.30	1.35	1.20 Boy	20	20,00



TEKNİK ÖZELLİKLER

- Malzeme : Polyolefin
- Daralma Oranı : 3/1
- Yanmazlık : Kendi kendine söner
- Çalışma Sıcaklığı : -45°C -- +125°C
- Voltaj : 600V



GWBT BARA İZOLASYON MAKARONU

Sipariş Kodu	Ölçü (mm)	Daralmadan Önce (mm)	Daralmadan Sonra (mm)		Makara / Mt.	Koli Miktarı	Birim Fiyat USD / Mt.
		İç Çap (D)	İç Çap (d)	Cidar Kalınlığı (W)			
4450	19/6	19	6	2.5	15	90	5,70
4451	25/10	25	10	2.9	15	60	7,50
4452	30/12	30	12	2.9	15	60	9,00
4454	40/16	40	16	2.9	15	60	11,00
4455	50/20	50	20	2.9	15	45	13,50
4456	65/25	65	25	2.9	15	45	17,00
4457	75/30	75	30	2.9	15	30	20,00
4458	85/35	85	35	2.9	15	30	23,00
4459	100/40	100	40	2.9	15	30	27,50
4460	120/50	120	50	2.9	15	15	31,00
4461	150/60	150	60	3	15	15	40,00

TEKNİK ÖZELLİKLER



- Malzeme : Polyolefin
- Daralma Oranı : 2.5/1
- Yanmazlık : Kendi kendine söner
- Min. Daralma Sıcaklığı : 105°C
- Voltaj : 36kV
- Renk: Kiremit Kırmızı



GWBT Bara İzalasyon Makaronu

36kV



Halogen Free

KABLO TOPLAMA ÇORABI

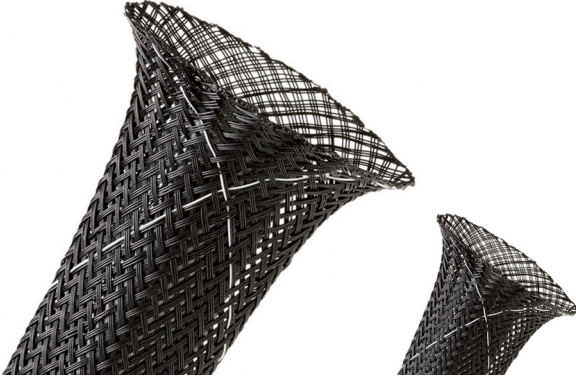

TEKNİK ÖZELLİKLER

- Malzeme : Pet (Polyester)
- Çalışma Sıcaklığı : -50°C -- +150°C
- Dayanım Üst Noktası : 220 °C
- Erime Noktası : +250 °C

Sipariş Kodu	Ölçü	Renk	Esneme Aralığı		Makara / Mt.	Birim Fiyat USD / Mt.
			Min (mm)	Max (mm)		
4501	3 mm	Siyah	1	6	100	0,24
4502	6 mm	Siyah	3	9	100	0,29
4503	8 mm	Siyah	5	16	100	0,30
4504	10 mm	Siyah	7	19	100	0,36
4505	12 mm	Siyah	8	24	100	0,43
4506	15 mm	Siyah	10	27	100	0,48
4507	20 mm	Siyah	14	30	100	0,56
4508	25 mm	Siyah	18	35	100	0,72
4509	30 mm	Siyah	20	50	50	0,87
4510	40 mm	Siyah	30	60	50	1,14
4511	50 mm	Siyah	40	80	25	1,40

ERİYEN BANTLAR



Sipariş Kodu	Ürün Kodu	Ölçüler	Koli Adet	Birim Fiyat USD / Adet
4801	GWEST - 1401	19mm x 0.8mm x 8m	60	2,50
4802	GWEST - 1402	50mm x 0.8mm x 8m	24	6,50

H CLASS CAM ELYAF SİLİKON İZOLELİ MAKARONLAR

Sipariş Kodu	Ölçü	Renk	Makara / Mt.	Koli Miktarı	Birim Fiyat USD / Mt.
4703	2 mm	Kırmızı	200	4.000	0,23
4705	3 mm	Kırmızı	100	2.500	0,36
4706	4 mm	Kırmızı	100	1.500	0,48
4707	5 mm	Kırmızı	100	1.200	0,58
4708	6 mm	Kırmızı	100	1.000	0,71
4709	7 mm	Kırmızı	100	800	0,82
4710	8 mm	Kırmızı	50	500	0,95
4711	10 mm	Kırmızı	50	500	1,30
4712	12 mm	Kırmızı	50	500	1,60
4713	14 mm	Kırmızı	50	500	1,92
4714	16 mm	Kırmızı	25	500	2,58
4715	18 mm	Kırmızı	25	400	3,36
4716	20 mm	Kırmızı	25	400	4,30
4717	25 mm	Kırmızı	25	250	8,20
4718	30 mm	Kırmızı	25	200	12,10
4719	35 mm	Kırmızı	25	200	14,20



TEKNİK ÖZELLİKLER

- Malzeme : Silikon İzoleli Cam Elyaf Örgü Makaron
- Kısa Süre Çalışma Sıcaklığı : -60 °C -- +250 °C
- Sürekli Çalışma Sıcaklığı : -40 °C -- +200 °C



MEKANİK, HİDROLİK El Aletleri



www.guvenelektrik.com.tr

YÜKSÜK SIKMA PENSELERİ



Kablo Yüksüğü



Kablo Yüksüğü



Kablo Yüksüğü



GW-B4

Teknik Bilgiler

Sipariş Kodu:	5026
Sıkma Aralığı:	0.25 - 6 mm ²
Uzunluk:	195 mm
Birim Fiyat USD	72,00

GW-5

Teknik Bilgiler

Sipariş Kodu:	5005
Sıkma Aralığı:	0.50 - 6 mm ²
Uzunluk:	210 mm
Birim Fiyat USD	76,00

GW-6

Teknik Bilgiler

Sipariş Kodu:	5006
Sıkma Aralığı:	6 - 16 mm ²
Uzunluk:	210 mm
Birim Fiyat USD	76,00

YÜKSÜK SIKMA PENSELERİ



Kablo Yüksüğü



Kablo Yüksüğü



Kablo Yüksüğü



GW-8

Teknik Bilgiler

Sipariş Kodu:	5008
Sıkma Aralığı:	0.08 - 6 mm ² (4 Köşe)
Uzunluk:	177 mm
Birim Fiyat USD	99,00

GW-9

Teknik Bilgiler

Sipariş Kodu:	5009
Sıkma Aralığı:	0.08 - 6 mm ² (6 Köşe)
Uzunluk:	177 mm
Birim Fiyat USD	115,00

GW-17

Teknik Bilgiler

Sipariş Kodu:	5015
Sıkma Aralığı:	25 - 35 mm ²
Uzunluk:	229 mm
Birim Fiyat USD	80,00

KABLO UCU SIKMA PENSELERİ



İzoleli Kablo Ucu



İzoleli Kablo Ucu

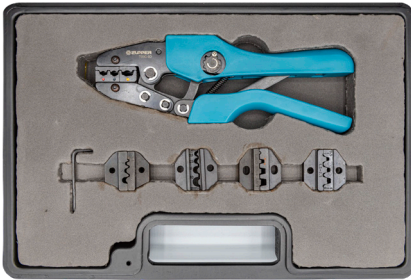

GW-1

Teknik Bilgiler

Sipariş Kodu:	5016
Sıkma Aralığı:	0.50 - 6 mm ²
Uzunluk:	260 mm
Birim Fiyat USD	65,00

GW-7

Teknik Bilgiler

Sipariş Kodu:	5017
Sıkma Aralığı:	0.50 - 6 mm ²
Uzunluk:	230 mm
Birim Fiyat USD	77,00

T03C-5D

Teknik Bilgiler

Sipariş Kodu:	5070
Ürün Adı:	Takım İçerikli Çanta

GW-5	Yüksük Sıkma 0.5 - 6 mm ²
GW-6	Yüksük Sıkma 6 - 16 mm ²
GW-1	Kablo Ucu Sıkma 6 - 16 mm ²
GW-11	İzolesiz Terminal Sıkma 6 - 16 mm ²
GW-T8	Kaynaklı Pabuç Sıkma 0.5 - 10 mm ²

Birim Fiyat USD	180,00
-----------------	---------------

KONNEKTÖR SIKMA PENSELERİ



İzolesiz Terminal

GW-11

Teknik Bilgiler

Sipariş Kodu:	5021
Sıkma Aralığı:	0.50 - 6 mm ²
Uzunluk:	230 mm
Birim Fiyat USD	77,00



İzolesiz Terminal

GW-12

Teknik Bilgiler

Sipariş Kodu:	5022
Sıkma Aralığı:	1.00 - 10 mm ²
Uzunluk:	230 mm
Birim Fiyat USD	77,00



Konnektör

GW-13

Teknik Bilgiler

Sipariş Kodu:	5013
Sıkma Aralığı:	28 - 22 / 24 - 18 mm ²
Uzunluk:	210 mm
Birim Fiyat USD	80,00

KABLO BAĞI SIKMA PENSELERİ



Kablo Bağı

TG-008

Teknik Bilgiler

Sipariş Kodu:	5054
Sıkma Aralığı:	2.2 - 4.8 mm ²
Malzeme:	Metal
Uzunluk:	160 mm
Birim Fiyat USD	75,00



Metal Kablo Bağı

TG-011

Teknik Bilgiler

Sipariş Kodu:	5056
Sıkma Aralığı:	4.6 - 12 mm ²
Uzunluk:	217 mm
Birim Fiyat USD	210,00

KABLO SIYIRMA PENSESİ



GW-318

Teknik Bilgiler

Sipariş Kodu:	5028
Sıkma Aralığı:	0.50 - 6 mm ²
Uzunluk:	365 mm
Birim Fiyat USD	36,00

KABLO PABUCU SIKMA PENSELERİ



Sıkmalı Kablo Pabucu

GW-T8

Teknik Bilgiler

Sipariş Kodu:	5018
Sıkma Aralığı:	1.5 - 10 mm ²
Uzunluk:	266 mm
Birim Fiyat USD	66,00



Sıkmalı Kablo Pabucu

GW-T9

Teknik Bilgiler

Sipariş Kodu:	5019
Sıkma Aralığı:	10 - 16 mm ²
Uzunluk:	266 mm
Birim Fiyat USD	66,00

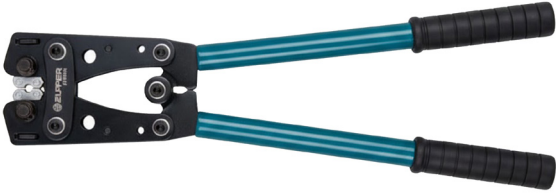

Sıkmalı Kablo Pabucu

JY-0650A

Teknik Bilgiler

Sipariş Kodu:	5074
Sıkma Aralığı:	6 - 50 mm ²
Uzunluk:	380mm
Birim Fiyat USD	95,00

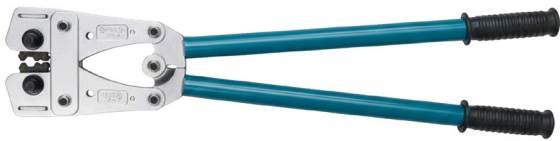

Sıkmalı Kablo Pabucu

JY-06120

Teknik Bilgiler

Sipariş Kodu:	5075
Sıkma Aralığı:	16 - 120 mm ²
Uzunluk:	650mm
Birim Fiyat USD	185,00

KABLO PABUCU SIKMA PENSELERİ



Sıkmalı Kablo Pabucu

YQK-70

Teknik Bilgiler

Sipariş Kodu:	5052
Sıkma Aralığı:	4 - 70 mm ² Bakır
Sıkma Kuvveti:	45kN
Sıkma Tipi:	Altıgen
Birim Fiyat USD	120,00



Sıkmalı Kablo Pabucu

YYQ-120

Teknik Bilgiler

Sipariş Kodu:	5050
Sıkma Aralığı:	10 - 120 mm ²
Sıkma Kuvveti:	60kN
Sıkma Tipi:	Altıgen
Birim Fiyat USD	150,00



Sıkmalı Kablo Pabucu

YQK-300

Teknik Bilgiler

Sipariş Kodu:	5051
Sıkma Aralığı:	10 - 300 mm ²
Sıkma Kuvveti:	70kN
Sıkma Tipi:	Altıgen
Birim Fiyat USD	160,00

KABLO PABUCU SIKMA PENSELERİ



Sıkmalı Kablo Pabucu

HZ-400

Teknik Bilgiler

Sipariş Kodu:	5071
Sıkma Aralığı:	16 - 400 mm ²
Sıkma Kuvveti:	120kN
Sıkma Tipi:	Altıgen
Birim Fiyat USD:	1.450,00



Sıkmalı Kablo Pabucu

CYO-400C

Teknik Bilgiler

Sipariş Kodu:	5072
Sıkma Aralığı:	16 - 400 mm ² Bakır
Sıkma Kuvveti:	126kN
Yağ Kapasitesi:	145cc
Birim Fiyat USD:	1.100,00

KABLO PABUCU SIKMA VE KESME PENSESİ



Sıkmalı Kablo Pabucu



Bakır / Alüminyum

HT-2430C

Teknik Bilgiler

Sipariş Kodu:	5073
Sıkma Kuvveti:	24kN
Sıkma Aralığı:	300 mm ² Bakır 240 mm ² Alüminyum
Kesme Aralığı	300 mm ² Bakır 300 mm ² Alüminyum
Birim Fiyat USD:	1.000,00

KABLO KESME MAKASLARI



Bakır / Alüminyum

CC-60

Teknik Bilgiler

Sipariş Kodu:	5040
Kesme Aralığı:	Maksimum 60 mm ² (AWG 1/0)
Malzeme:	Alüminyum / Bakır
Birim Fiyat USD	54,00

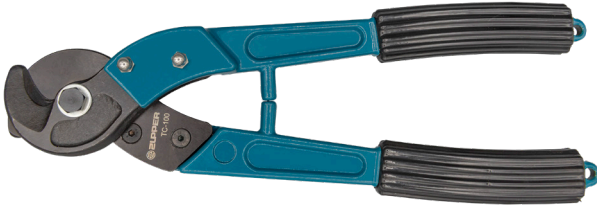

Bakır / Alüminyum

TC-100

Teknik Bilgiler

Sipariş Kodu:	5041
Kesme Aralığı:	120 mm ²
Malzeme:	Alüminyum / Bakır
Uzunluk	320 mm
Birim Fiyat USD	80,00

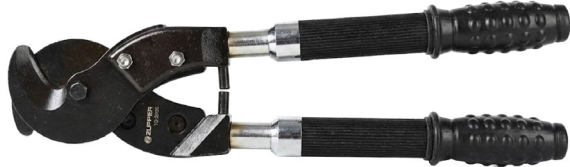

Bakır / Alüminyum

TC-250S

Teknik Bilgiler

Sipariş Kodu:	5042
Kesme Aralığı:	240 mm ²
Malzeme:	Alüminyum / Bakır
Uzunluk	415-565 mm
Birim Fiyat USD	175,00



Bakır / Alüminyum

TC-38

Teknik Bilgiler

Sipariş Kodu:	5077
Kesme Aralığı:	240 mm ² - 400 mm ² Bakır
	400 mm ² - 500 mm ² Alüminyum
	Ø38 mm - Çelik Özlü Kablo
Birim Fiyat USD	220,00

KABLO KESME MAKASLARI



Bakır / Alüminyum

TCR-325

Teknik Bilgiler

Sipariş Kodu:	5067
Kesme Aralığı:	150 mm ²
Malzeme:	Alüminyum / Bakır
Uzunluk	260 mm
Birim Fiyat USD	210,00



Bakır Alüminyum Zırlı Kablo Alüminyum Çelik Özlü

ZCR-52

Teknik Bilgiler

Sipariş Kodu:	5069
Kesme Aralığı:	Ø50 mm
Malzeme:	Alüminyum / Bakır / Zırlı
Uzunluk	360 - 480 mm
Birim Fiyat USD	350,00



Bakır Alüminyum Zırlı Kablo Alüminyum Çelik Özlü

ZC-G32A

Teknik Bilgiler

Sipariş Kodu:	5078
Kesme Aralığı:	100 mm ² Çelik Örgülü Tel
	600 mm ² Alüminyum Çelik Özlü
	Ø32 mm Çelik Özlü Kablo
Birim Fiyat USD	600,00



Bakır Alüminyum Zırlı Kablo Alüminyum Çelik Özlü

ZC-G40

Teknik Bilgiler

Sipariş Kodu:	5070
Kesme Aralığı:	120 mm ² Çelik Örgülü Tel
	800 mm ² Alüminyum Çelik Özlü
	Ø36 mm Çelik Özlü Kablo
Birim Fiyat USD	700,00



BUTON SERİSİ Ve Aksesuarları



Ø 22mm BUTON SERİSİ



YAYLI BUTONLAR

	Sipariş Kodu	Ürün Kodu	Kontakt	Açıklama	Renk	Kutu Adet	Koli Adet	Birim Fiyat TL / Adet
	6001	A5 - 10	1NO	Yaylı Buton	Yeşil	10	300	120,00
	6002	A5 - 01	1NC	Yaylı Buton	Kırmızı	10	300	120,00
	6003	A5 - 11	1NO	Yaylı Buton	Sarı	10	300	120,00
	6004	A5 - 21	1NO	Yaylı Buton	Mavi	10	300	120,00
	6005	A5 - 31	1NO	Yaylı Buton	Beyaz	10	300	120,00
	6006	A5 - 41	1NO	Yaylı Buton	Siyah	10	300	120,00

İŞARETLİ YAYLI BUTONLAR

	6007	A5 - 10/1	1NO	İşaretlili Yaylı Buton	Yeşil	10	300	140,00
	6008	A5 - 01/2	1NC	İşaretlili Yaylı Buton	Kırmızı	10	300	140,00
	6009	A5 - 10/3	1NO	İşaretlili Yaylı Buton	Mavi	10	300	140,00
	6010	A5 - 10/4	1NO	İşaretlili Yaylı Buton	Siyah	10	300	140,00

İŞIKLI YAYLI BUTONLAR

	6011	A5 - 10D	1NO	Işıklı Yaylı Buton 220V AC/DC	Yeşil	10	300	215,00
	6012	A5 - 01D	1NC		Kırmızı	10	300	215,00
	6013	A5 - 11D	1NO		Sarı	10	300	215,00
	6014	A5 - 21D	1NO		Mavi	10	300	215,00
	6015	A5 - 31D	1NO		Beyaz	10	300	215,00
	6016	A5 - 10D-110	1NO	Işıklı Yaylı Buton 110V AC/DC	Yeşil	10	300	215,00
	6017	A5 - 01D-110	1NC		Kırmızı	10	300	215,00
	6018	A5 - 11D-110	1NO		Sarı	10	300	215,00
	6019	A5 - 21D-110	1NO		Mavi	10	300	215,00
	6020	A5 - 31D-110	1NO		Beyaz	10	300	215,00
	6021	A5 - 10D-24	1NO	Işıklı Yaylı Buton 24V AC/DC	Yeşil	10	300	215,00
	6022	A5 - 01D-24	1NC		Kırmızı	10	300	215,00
	6023	A5 - 11D-24	1NO		Sarı	10	300	215,00
	6024	A5 - 21D-24	1NO		Mavi	10	300	215,00
	6025	A5 - 31D-24	1NO		Beyaz	10	300	215,00

Ø 22mm BUTON SERİSİ

KALICI MANDAL BUTONLAR

	Sipariş Kodu	Ürün Kodu	Kontakt	Açıklama	Kutu Adet	Koli Adet	Birim Fiyat TL / Adet
	6027	A5 - 10X	1NO	0 -1 Mandal Buton		10	300
6028	A5 - 20XS	2NO	1-0-2 Mandal Buton		10	300	185,00



KAYICI MANDAL BUTONLAR

	Sipariş Kodu	Ürün Kodu	Kontakt	Açıklama	Kutu Adet	Koli Adet	Birim Fiyat TL / Adet
	6029	A5 - 10X/FU	1NO	0 -1 Mandal Buton		10	300
6030	A5 - 20XS/FU	2NO	1-0-2 Mandal Buton		10	300	200,00

KALICI - KAYICI MANDAL BUTON

	Sipariş Kodu	Ürün Kodu	Kontakt	Açıklama	Kutu Adet	Koli Adet	Birim Fiyat TL / Adet
	6026	A5 - 20XS/F	2NO	1-0-2 Mandal Buton	Sağ Pozisyon Kalıcı Sol Pozisyon Kayıcı	10	300

ANAHTARLI KALICI BUTONLAR

	Sipariş Kodu	Ürün Kodu	Kontakt	Açıklama	Kutu Adet	Koli Adet	Birim Fiyat TL / Adet
	6049	A5 - 10Y	1NO	0 -1 Anahtarlı Buton		10	300
6050	A5 - 20YS	2NO	1-0-2 Anahtarlı Buton		10	300	250,00

Ø 22mm BUTON SERİSİ

IŞIKLI KALICI MANDAL BUTONLAR



	Sipariş Kodu	Ürün Kodu	Kontak	Açıklama	Renk	Kutu Adet	Koli Adet	Birim Fiyat TL / Adet
	6031	A5 - 10XD	1NO	 O-1 Işıklı Mandal Buton 220V AC/DC	Yeşil	10	300	220,00
	6032	A5 - 01XD	1NC		Kırmızı	10	300	
	6033	A5 - 11XD	1NO	 O-1 Işıklı Mandal Buton 24V AC/DC	Sarı	10	300	220,00
	6043	A5 - 10XD-24	1NO		Yeşil	10	300	
	6044	A5 - 01XD-24	1NC	 O-1 Işıklı Mandal Buton 24V AC/DC	Kırmızı	10	300	220,00
	6045	A5 - 11XD-24	1NO		Sarı	10	300	
	6034	A5 - 20XSD	2NO	 1-0-2 Işıklı Mandal Buton 220V AC/DC	Yeşil	10	300	265,00
	6035	A5 - 02XSD	2NC		Kırmızı	10	300	
	6036	A5 - 21XSD	2NO	 1-0-2 Işıklı Mandal Buton 24V AC/DC	Sarı	10	300	265,00
	6046	A5 - 20XSD-24	2NO		Yeşil	10	300	
	6047	A5 - 02XSD-24	2NC	 1-0-2 Işıklı Mandal Buton 24V AC/DC	Kırmızı	10	300	265,00
	6048	A5 - 21XSD-24	2NO		Sarı	10	300	

Ø 22mm BUTON SERİSİ

40mm KALICI MANTAR BUTON

	Sipariş Kodu	Ürün Kodu	Kontakt	Açıklama	Renk	Kutu Adet	Koli Adet	Birim Fiyat TL / Adet
	6054	A5 - 01ZS	1NC	Stop Mantar Buton	 Kırmızı	10	300	155,00

40mm KALICI ANAHTARLI MANTAR BUTON

	6075	BZ - 01ZA	1NC	Anahtarlı Stop Mantar Buton	 Kırmızı	10	300	230,00
--	------	-----------	-----	-----------------------------	---	----	-----	---------------







40mm KAYICI MANTAR BUTONLAR

	6051	A5 - 01M	1NC	Stop Mantar Buton	 Kırmızı	10	300	140,00
	6052	A5 - 10M	1NO	Start Mantar Buton	 Yeşil	10	300	140,00
	6053	A5 - 41M	1NO	Start Mantar Buton	 Siyah	10	300	140,00

İKİZ BUTONLAR

	6059	A5 - 11R	1NO+1NC	İkiz Buton	 Yeşil - Kırmızı	10	300	220,00
	6062	A5 - 11RD	1NO+1NC	Işıklı İkiz Buton 220V AC/DC	 Kırmızı - Yeşil	10	300	310,00
	6061	A5 - 11RD-110	1NO+1NC	Işıklı İkiz Buton 110V AC/DC	 Kırmızı - Yeşil	10	300	310,00
	6060	A5 - 11RD-24	1NO+1NC	Işıklı İkiz Buton 24V AC/DC	 Kırmızı - Yeşil	10	300	310,00

Ø 22mm BUTON SERİSİ AKSESUARLARI

	Sipariş Kodu	Ürün Kodu	Açıklama	Kutu Adet	Birim Fiyat TL / Adet
	6101	A - 10	1NO Start Kontakt	250	49,00
	6102	A - 01	1NC Stop Kontakt	250	49,00
	6103	A - D2	BA9S Led Kontakt Yuvası (Buton için)	200	57,00
	6104	FC	Plastik Buton Rozeti	100	6,50
	6105	FD/60	60mm Acil Stop Etiket	100	17,00
	6106	EC5-1	Acil Stop Butonu Koruma Kapağı	20	110,00
	6107	FH	Buton Koruma Kapağı	4	90,00
	6108	BK	Buton Koruma Kılıfı	100	14,00

BOŞ KUMANDA KUTULARI

Sipariş Kodu	Ürün Kodu	Açıklama	Renk	Kutu Adet	Koli Adet	Birim Fiyat TL / Adet
6114	GBK - 1	1'li Boş Kumanda Kutusu	Sarı-Siyah	1	100	80,00
6116	GBK - 2	2'li Boş Kumanda Kutusu	Sarı-Siyah	1	100	100,00
6118	GBK - 3	3'lü Boş Kumanda Kutusu	Sarı-Siyah	1	100	130,00
6120	GBK - 4	4'lü Boş Kumanda Kutusu	Sarı-Siyah	1	50	165,00
6122	GBK - 5	5'li Boş Kumanda Kutusu	Sarı-Siyah	1	50	240,00
6124	GBK - 6	6'lı Boş Kumanda Kutusu	Sarı-Siyah	1	50	240,00

ARAÇ VİNÇ KUMANDASI

Sipariş Kodu	Ürün Kodu	Kontakt	Açıklama	Renk	Kutu Adet	Koli Adet	Birim Fiyat USD / Adet
6709	KB-2	2x2N/O	Tek Hızlı 2'li Çift Kontaktlı	Sarı-Siyah	1	50	12,00

KUTULU ACİL STOP BUTON

Sipariş Kodu	Ürün Kodu	Kontakt	Açıklama	Renk	Kutu Adet	Koli Adet	Birim Fiyat TL / Adet
6125	LAY2 - KSE542	NC	1'li Mantar Acil Stop Buton	Sarı-Siyah	1	100	210,00

VİNÇ KUMANDALARI

VİNÇ KUMANDALAR

	Sipariş Kodu	Ürün Kodu	Açıklama	Kutu Adet	Koli Adet	Birim Fiyat USD / Adet
	6701	VK - 2	Vinç Kumanda 2'li Tek Hızlı	1	72	4,00
	6702	VK - 4	Vinç Kumanda 4'li Tek Hızlı	1	48	6,00
	6703	VK - 6	Vinç Kumanda 6'li Tek Hızlı	1	42	8,00
	6704	VK - 8	Vinç Kumanda 8'li Tek Hızlı	1	30	10,00

ACİL STOPLU VİNÇ KUMANDALAR

	6705	VKB - 3	Vinç Kumanda 3'li Tek Hızlı	1	50	15,00
	6706	VKB - 5	Vinç Kumanda 5'li Tek Hızlı	1	40	22,00
	6707	VKB - 7	Vinç Kumanda 7'li Tek Hızlı	1	30	29,00
	6708	VKB - 9	Vinç Kumanda 9'li Tek Hızlı	1	25	35,00

Ø 22mm LED'Lİ SİNYALLER



Sipariş Kodu	Ürün Kodu	Çap (mm)	Açıklama	Renk	Kutu Adet	Koli Adet	Birim Fiyat TL / Adet
6601	22 - K	22	Led Sinyal 220V. AC-DC	● Kırmızı	10	500	47,00
6602	22 - Y	22		● Yeşil	10	500	47,00
6603	22 - S	22		● Sarı	10	500	47,00
6604	22 - M	22		● Mavi	10	500	47,00
6605	22 - B	22		○ Beyaz	10	500	50,00
6606	22 - 110V - K	22	Led Sinyal 110V. AC-DC	● Kırmızı	10	500	47,00
6607	22 - 110V - Y	22		● Yeşil	10	500	47,00
6608	22 - 110V - S	22		● Sarı	10	500	47,00
6609	22 - 110V - M	22		● Mavi	10	500	47,00
6610	22 - 110V - B	22		○ Beyaz	10	500	50,00
6611	22 - 24V - K	22	Led Sinyal 24V. AC-DC	● Kırmızı	10	500	47,00
6612	22 - 24V - Y	22		● Yeşil	10	500	47,00
6613	22 - 24V - S	22		● Sarı	10	500	47,00
6614	22 - 24V - M	22		● Mavi	10	500	47,00
6615	22 - 24V - B	22		○ Beyaz	10	500	50,00

Ø 16mm LED'Lİ SİNYALLER



Sipariş Kodu	Ürün Kodu	Çap (mm)	Açıklama	Renk	Kutu Adet	Koli Adet	Birim Fiyat TL / Adet
6621	16 - K	16	Led Sinyal 220V. AC-DC	● Kırmızı	20	1.000	60,00
6622	16 - Y	16		● Yeşil	20	1.000	60,00
6623	16 - S	16		● Sarı	20	1.000	60,00
6624	16 - M	16		● Mavi	20	1.000	60,00
6625	16 - B	16		○ Beyaz	20	1.000	82,00
6631	16 - 24V - K	16	Led Sinyal 24V. AC-DC	● Kırmızı	20	1.000	60,00
6632	16 - 24V - Y	16		● Yeşil	20	1.000	60,00
6633	16 - 24V - S	16		● Sarı	20	1.000	60,00
6634	16 - 24V - M	16		● Mavi	20	1.000	60,00
6635	16 - 24V - B	16		○ Beyaz	20	1.000	82,00





Ø 22mm LED'Lİ SİNYALLER

Sipariş Kodu	Ürün Kodu	Çap (mm)	Açıklama	Renk	Kutu Adet	Koli Adet	Birim Fiyat TL / Adet
6200	AD116 - K	22		● Kırmızı	10	500	35,00
6201	AD116 - Y	22	Led Sinyal 220V. AC-DC	● Yeşil	10	500	35,00
6202	AD116 - S	22		● Sarı	10	500	35,00
6203	AD116 - 24V - K	22		● Kırmızı	10	500	35,00
6204	AD116 - 24V - Y	22	Led Sinyal 24V. AC-DC	● Yeşil	10	500	35,00
6205	AD116 - 24V - S	22		● Sarı	10	500	35,00





Ekonomik Tip

FLK®

Ø 22mm VOLTMETRE

	Sipariş Kodu	Ürün Kodu	Çap (mm)	Açıklama	Renk	Kutu Adet	Koli Adet	Birim Fiyat TL / Adet
	6501	22 VS - K	22	24 - 550V Led'li Voltmetre	● Kırmızı	10	500	168,00
	6502	22 VS - Y	22	24 - 550V Led'li Voltmetre	● Yeşil	10	500	168,00
	6503	22 VS - S	22	24 - 550V Led'li Voltmetre	● Sarı	10	500	168,00
	6504	22 VS - M	22	24 - 550V Led'li Voltmetre	● Mavi	10	500	168,00
	6505	22 VS - B	22	24 - 550V Led'li Voltmetre	○ Beyaz	10	500	168,00

Ø 22mm AMPERMETRE

	Sipariş Kodu	Ürün Kodu	Çap (mm)	Açıklama	Renk	Kutu Adet	Koli Adet	Birim Fiyat TL / Adet
	6511	22 AS - K	22	0 - 100A Led'li Ampermetre Akım Trafolu	● Kırmızı	10	300	330,00
	6512	22 AS - Y	22	0 - 100A Led'li Ampermetre Akım Trafolu	● Yeşil	10	300	330,00
	6513	22 AS - S	22	0 - 100A Led'li Ampermetre Akım Trafolu	● Sarı	10	300	330,00
	6514	22 AS - M	22	0 - 100A Led'li Ampermetre Akım Trafolu	● Mavi	10	300	330,00
	6515	22 AS - B	22	0 - 100A Led'li Ampermetre Akım Trafolu	○ Beyaz	10	300	330,00

BA9S LED AMPULLER



Sipariş Kodu	Ürün Kodu	Açıklama	Renk	Kutu Adet	Koli Adet	Birim Fiyat TL / Adet
6521	BA9SC - K	Led Ampul 220V. AC-DC	● Kırmızı	50	4.000	50,00
6522	BA9SC - Y		● Yeşil	50	4.000	50,00
6523	BA9SC - S		● Sarı	50	4.000	50,00
6524	BA9SC - M		● Mavi	50	4.000	50,00
6525	BA9SC - B		○ Beyaz	50	4.000	62,00
6526	BA9SC - 110V - K	Led Ampul 110V. AC-DC	● Kırmızı	50	4.000	50,00
6527	BA9SC - 110V - Y		● Yeşil	50	4.000	50,00
6528	BA9SC - 110V - S		● Sarı	50	4.000	50,00
6529	BA9SC - 110V - M		● Mavi	50	4.000	50,00
6530	BA9SC - 110V - B		○ Beyaz	50	4.000	62,00
6531	BA9SC - 24V - K	Led Ampul 24V. AC-DC	● Kırmızı	50	4.000	50,00
6532	BA9SC - 24V - Y		● Yeşil	50	4.000	50,00
6533	BA9SC - 24V - S		● Sarı	50	4.000	50,00
6534	BA9SC - 24V - M		● Mavi	50	4.000	50,00
6535	BA9SC - 24V - B		○ Beyaz	50	4.000	62,00

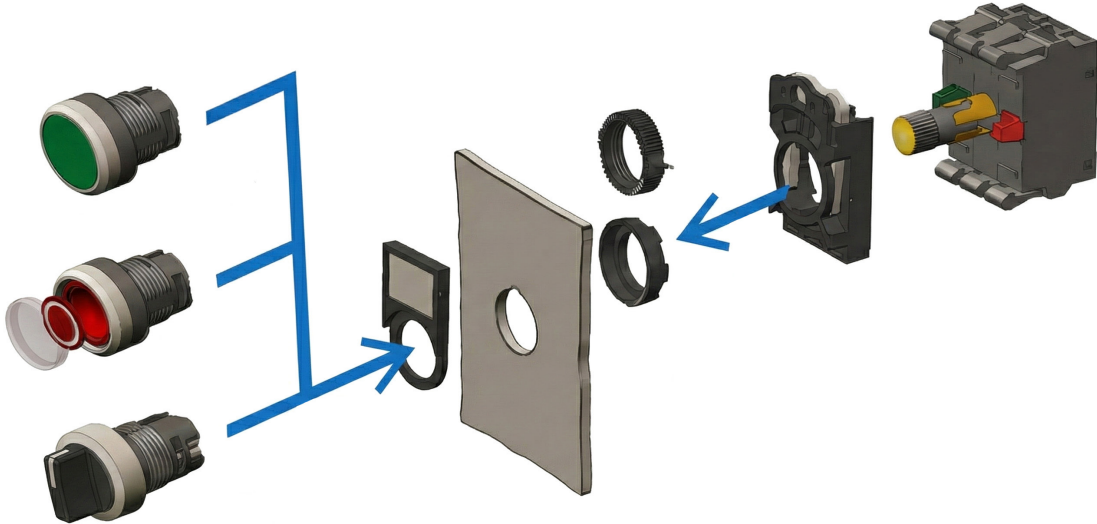

BUZZER'LAR

Ø 22mm LED'Lİ BUZZERLAR (90dB)



Sipariş Kodu	Ürün Kodu	Çap (mm)	Açıklama	Renk	Kutu Adet	Koli Adet	Birim Fiyat TL / Adet
6640	22DS/MS	22	Sesli Led Flaşör İkazlı 220V. AC	● Kırmızı	10	500	180,00
6641	22DS/MS24	22	Sesli Led Flaşör İkazlı 24V. AC/DC	● Kırmızı	10	500	180,00

MOTORLU SİRENLER



Sipariş Kodu	Ürün Kodu	Açıklama	Kutu Adet	Koli Adet	Birim Fiyat TL / Adet
6651	MS - 190	75mm Metal Gövde 220V. AC (110 - 130dB)	1	40	730,00
6652	MS - 190 - 24	75mm Metal Gövde 24V. DC (110 - 130dB)	1	40	730,00

PANO İÇİ TERMOSTATLAR

Çalışma Ömrü : 100.000 Açma Kapama
Ölçüler : 60x33x43
Ağırlık : 40 gr
Koruma Sınıfı : IP20



Sipariş Kodu	Ürün Kodu	Kontakt	Açıklama ve Çalışma Sıcaklığı	Kutu Adet	Koli Adet	Birim Fiyat TL / Adet
6681	KTS - 011	NO	Soğutma Termostatı (0 - 60°C)	1	200	290,00
6682	KTO - 011	NC	Isıtma Termostatı (0 - 60°C)	1	200	290,00

Ø 22mm POTANSİYOMETRE

	Birim Fiyat TL / Adet	230,00
	Sipariş Kodu	6665
	Ürün Kodu	APT22 - 5K
	Çap (mm)	22
	Kutu Adet	10
	Koli Adet	500
	Açıklama	5K Potansiyometre Tek Turlu 220V. AC

	Birim Fiyat TL / Adet	230,00
	Sipariş Kodu	6666
	Ürün Kodu	APT22 - 10K
	Çap (mm)	22
	Kutu Adet	10
	Koli Adet	500
	Açıklama	10K Potansiyometre Tek Turlu 220V. AC

Ø 22mm ISİMETRE



Sipariş Kodu	Ürün Kodu	Çap (mm)	Sıcaklık	Renk	Kutu Adet	Koli Adet	Birim Fiyat TL / Adet
6516	22-TM-K	22	-20 - +99°C	● Kırmızı	10	500	260,00
6517	22-TM-Y	22	-20 - +99°C	● Yeşil	10	500	260,00
6518	22-TM-S	22	-20 - +99°C	● Sarı	10	500	260,00



SWITCH GRUBU

GLS - AZ - GMS Serisi



GLS SERİSİ LİMİT SWITCH

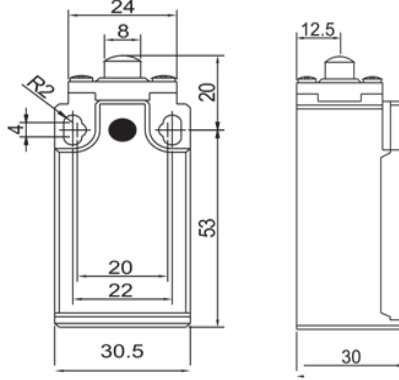

Birim Fiyat USD / Adet	7,20 \$
Sipariş Kodu	6801
Ürün Kodu	GLS -101
Kutu Adet	10
Koli Adet	100
Açıklama	Kısa Dikey Metal Pim 1NO + 1NC

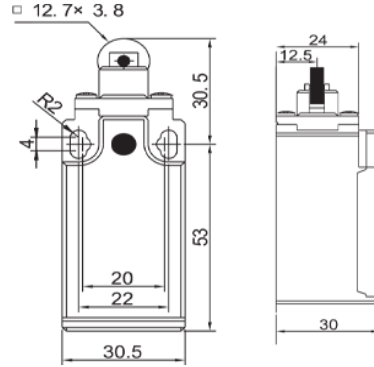

Birim Fiyat USD / Adet	7,20 \$
Sipariş Kodu	6802
Ürün Kodu	GLS -103
Kutu Adet	10
Koli Adet	100
Açıklama	Dikey Metal Makaralı 1NO + 1NC

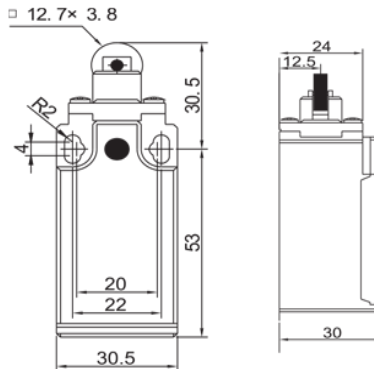

RESETLİ

Birim Fiyat USD / Adet	7,70 \$
Sipariş Kodu	6803
Ürün Kodu	GLS -103R
Kutu Adet	10
Koli Adet	100
Açıklama	Dikey Metal Makaralı Resetli 1NO + 1NC

GLS SERİSİ LİMİT SWITCH

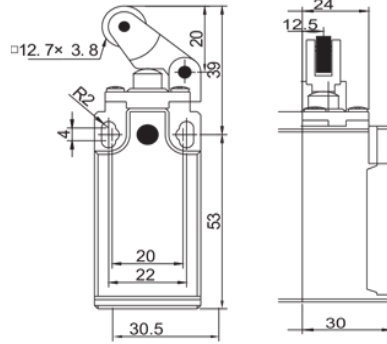

Birim Fiyat USD / Adet	7,20 \$
Sipariş Kodu	6804
Ürün Kodu	GLS -111
Kutu Adet	10
Koli Adet	100
Açıklama	Açısal Metal Makaralı Tek Yön 1NO + 1NC

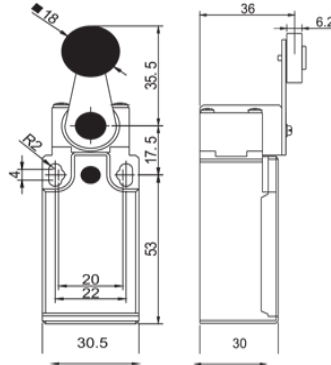

Birim Fiyat USD / Adet	7,20 \$
Sipariş Kodu	6805
Ürün Kodu	GLS -121
Kutu Adet	10
Koli Adet	100
Açıklama	Dikey Metal Makaralı Çift Yön 1NO + 1NC

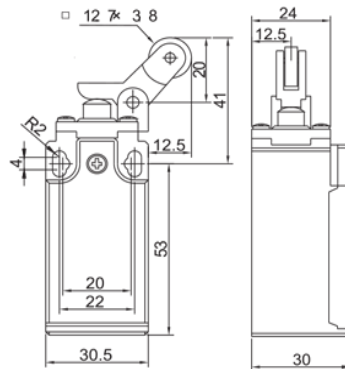

Birim Fiyat USD / Adet	7,20 \$
Sipariş Kodu	6806
Ürün Kodu	GLS -127
Kutu Adet	10
Koli Adet	100
Açıklama	Ters Açısal Metal Makaralı Tek Yön 1NO + 1NC

GLS SERİSİ LİMİT SWITCH

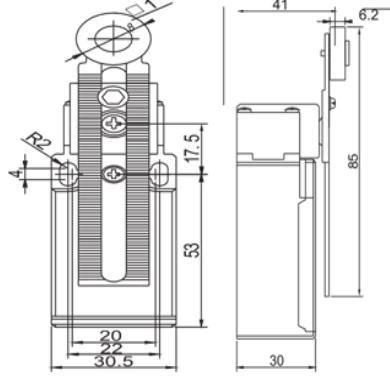

Birim Fiyat USD / Adet	7,50 \$
Sipariş Kodu	6807
Ürün Kodu	GLS -131
Kutu Adet	10
Koli Adet	100
Açıklama	Ayarlanabilir Metal Makaralı Çift Yön İNO + İNC

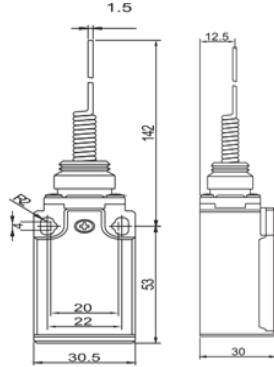

Birim Fiyat USD / Adet	7,50 \$
Sipariş Kodu	6808
Ürün Kodu	GLS -161
Kutu Adet	10
Koli Adet	100
Açıklama	Çok Yönlü Spiral Tel Uç İNO + İNC

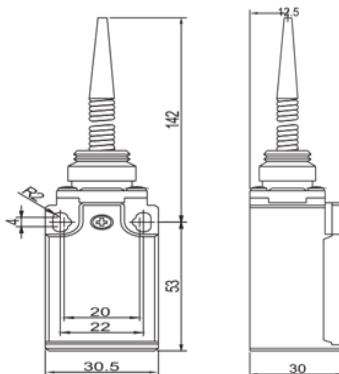

Birim Fiyat USD / Adet	7,50 \$
Sipariş Kodu	6809
Ürün Kodu	GLS -171
Kutu Adet	10
Koli Adet	100
Açıklama	Çok Yönlü Spiral Plastik Uç İNO + İNC

GLS SERİSİ LİMİT SWITCH

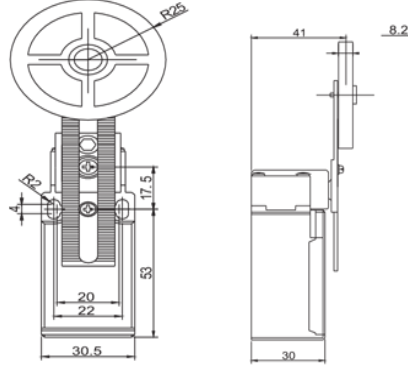

Birim Fiyat USD / Adet	7,50 \$
Sipariş Kodu	6810
Ürün Kodu	GLS -191
Kutu Adet	1
Koli Adet	100
Açıklama	Ayarlanabilir Kauçuk Makara Çift Yön 1NO + 1NC

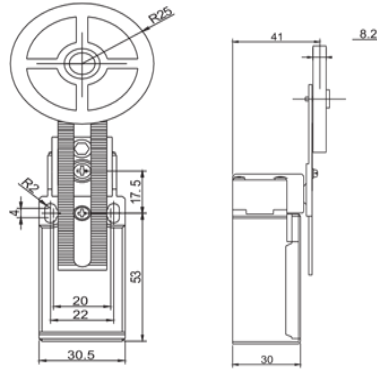

Birim Fiyat USD / Adet	9,50 \$
Sipariş Kodu	6800
Ürün Kodu	GLS -191R
Kutu Adet	1
Koli Adet	100
Açıklama	Ayarlanabilir Kauçuk Makara Çift Yön Resetli 1NO + 1NC

RESETLİ



AZ SERİSİ MİKRO SWITCH

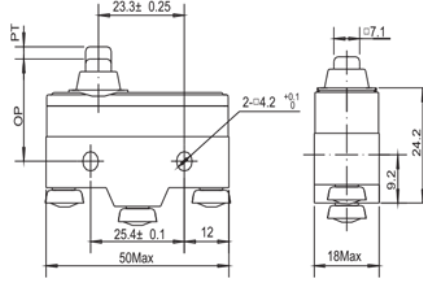

Birim Fiyat USD / Adet	4,25 \$
Sipariş Kodu	6812
Ürün Kodu	AZ - 15GD - B
Kutu Adet	20
Koli Adet	500
Açıklama	Kalın Uzun Pimli 15A 1NO + 1NC

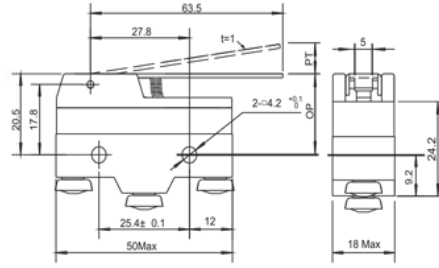

Birim Fiyat USD / Adet	4,25 \$
Sipariş Kodu	6814
Ürün Kodu	AZ - 15GW - B
Kutu Adet	20
Koli Adet	500
Açıklama	Uzun Palet 15A 1NO + 1NC

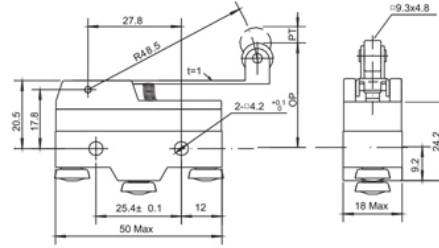

Birim Fiyat USD / Adet	4,60 \$
Sipariş Kodu	6815
Ürün Kodu	AZ - 15GW2 - B
Kutu Adet	20
Koli Adet	500
Açıklama	Uzun Palet Metal Makaralı 15A 1NO + 1NC

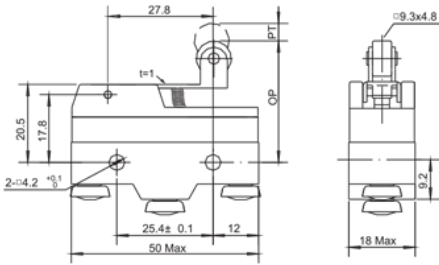

Birim Fiyat USD / Adet	4,60 \$
Sipariş Kodu	6818
Ürün Kodu	AZ - 15GW22 - B
Kutu Adet	20
Koli Adet	500
Açıklama	Kısa Metal Makaralı 15A 1NO + 1NC

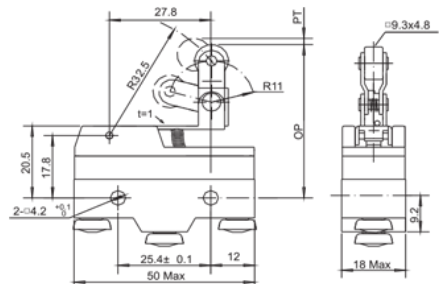

Birim Fiyat USD / Adet	5,10 \$
Sipariş Kodu	6819
Ürün Kodu	AZ - 15GW2277 - B
Kutu Adet	20
Koli Adet	500
Açıklama	Tahrikli Metal Makaralı 15A 1NO + 1NC

AZ SERİSİ MİKRO SWITCH

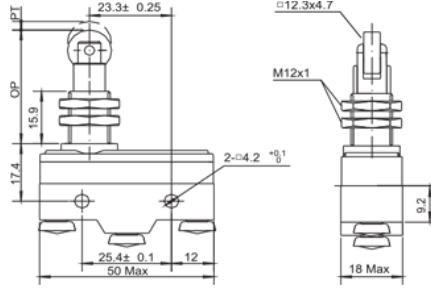

Birim Fiyat USD / Adet	6,40 \$
Sipariş Kodu	6820
Ürün Kodu	AZ - 15GQ22 - B
Kutu Adet	20
Koli Adet	500
Açıklama	Dikey Metal Makaralı 15A 1NO + 1NC

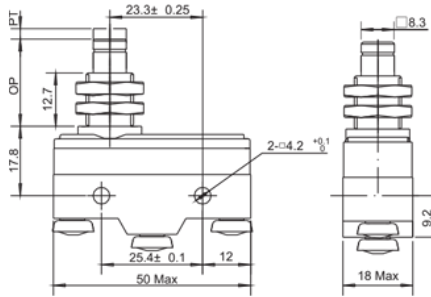

Birim Fiyat USD / Adet	5,60 \$
Sipariş Kodu	6821
Ürün Kodu	AZ - 15GQ - B
Kutu Adet	20
Koli Adet	500
Açıklama	Kalın Kısa Metal Pimli 15A 1NO + 1NC

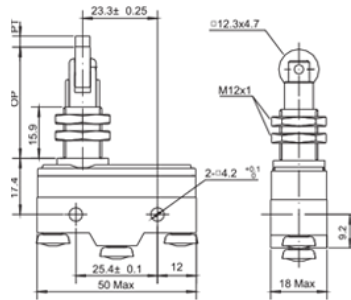

Birim Fiyat USD / Adet	6,40 \$
Sipariş Kodu	6822
Ürün Kodu	AZ - 15GQ21 - B
Kutu Adet	20
Koli Adet	500
Açıklama	Yan Dik Metal Makaralı 15A 1NO + 1NC

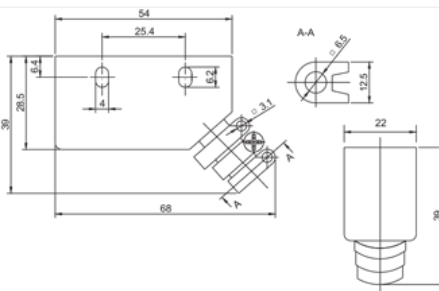

Birim Fiyat USD / Adet	0,73 \$
Sipariş Kodu	6824
Ürün Kodu	XAP - Y
Kutu Adet	100
Koli Adet	1.000
Açıklama	Koruma Kabi

GMS SERİSİ MİKRO SWITCH



Birim Fiyat USD / Adet	1,15 \$		
Sipariş Kodu	6830	Ürün Kodu	GMS - 100C
Kutu Adet	100	Koli Adet	2.000
Açıklama	10 Amper Plastik Pimli Mikro Switch		
Birim Fiyat USD / Adet	1,22 \$		
Sipariş Kodu	6831	Ürün Kodu	GMS - 101C
Kutu Adet	100	Koli Adet	2.000
Açıklama	10 Amper Orta Kollu Mikro Switch		
Birim Fiyat USD / Adet	1,22 \$		
Sipariş Kodu	6832	Ürün Kodu	GMS - 102C
Kutu Adet	100	Koli Adet	2.000
Açıklama	10 Amper Kısa Kollu Mikro Switch		
Birim Fiyat USD / Adet	1,38 \$		
Sipariş Kodu	6833	Ürün Kodu	GMS - 103C
Kutu Adet	100	Koli Adet	2.000
Açıklama	10 Amper Uzun Kollu Metal Makaralı Mikro Switch		
Birim Fiyat USD / Adet	1,38 \$		
Sipariş Kodu	6834	Ürün Kodu	GMS - 104C
Kutu Adet	100	Koli Adet	2.000
Açıklama	10 Amper Kısa Kollu Metal Makaralı Mikro Switch		
Birim Fiyat USD / Adet	1,38 \$		
Sipariş Kodu	6835	Ürün Kodu	GMS - 105C
Kutu Adet	100	Koli Adet	2.000
Açıklama	10 Amper Uzun Kollu Mikro Switch		
Birim Fiyat USD / Adet	1,38 \$		
Sipariş Kodu	6836	Ürün Kodu	GMS - 106C
Kutu Adet	100	Koli Adet	2.000
Açıklama	10 Amper Kıvrık Kollu Mikro Switch		

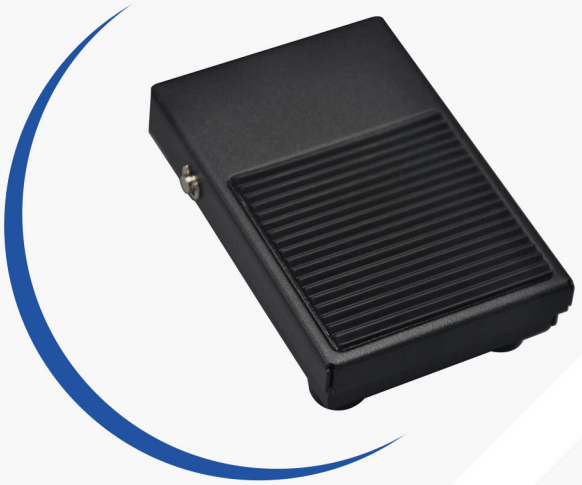

AYAK PEDALLARI

Metal Döküm



AYAK PEDALLARI

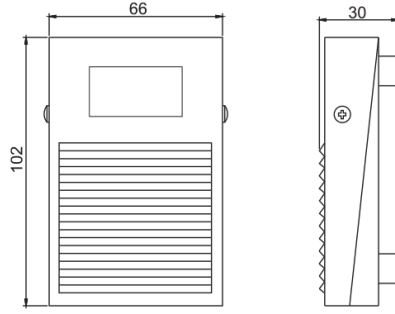

Birim Fiyat USD / Adet	8,50 \$
Sipariş Kodu	6901
Ürün Kodu	AP - 1
Kutu Adet	1
Koli Adet	100
Açıklama	Metal Döküm Pedal 2mt Kablolu

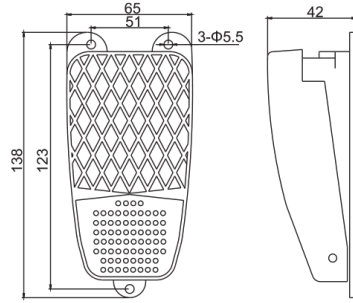

Birim Fiyat USD / Adet	12,00 \$
Sipariş Kodu	6902
Ürün Kodu	AP - 2
Kutu Adet	1
Koli Adet	100
Açıklama	Alüminyum Döküm Pedal 1mt Kablolu

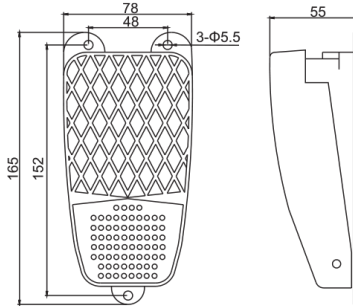

Birim Fiyat USD / Adet	15,50 \$
Sipariş Kodu	6903
Ürün Kodu	AP - 3
Kutu Adet	1
Koli Adet	50
Açıklama	Alüminyum Döküm Pedal 1mt Kablolu

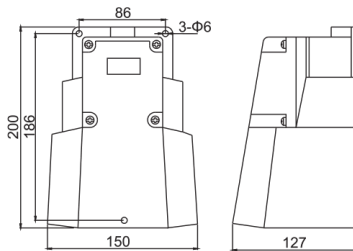

Birim Fiyat USD / Adet	38,50 \$
Sipariş Kodu	6904
Ürün Kodu	AP - 9
Kutu Adet	1
Koli Adet	20
Açıklama	Metal Döküm Pedal



GÜVEN
ELEKTRİK ELEKTRONİK LTD. ŞTİ.

GWEST®

WWOER®

**Başarılar
Karşılıklı Güven'e Bağlıdır.**

MERKEZ:

İkitelli Organize Sanayi Bölgesi
Mutsan Sanayi Sitesi M12 Blok No: 52-54
Başakşehir / İstanbul
Tel: 0212 485 05 40
Fax: 0212 486 05 61

İMALAT:

İkitelli Organize Sanayi Bölgesi
Mutsan Sanayi Sitesi M5 Blok No: 2-12
Başakşehir / İstanbul
Tel: 0212 361 69 61
Fax: 0212 361 69 63